

MFJ

Memory Keyer

Model MFJ-495



INSTRUCTION MANUAL

CAUTION: Read All Instructions Before Operating Equipment

MFJ ENTERPRISES, INC.

300 Industrial Park Road
Starkville, MS 39759 USA
Tel: 662-323-5869 Fax: 662-323-6551

DISCLAIMER

Information in this manual is designed for **user purposes only** and is *not* intended to supersede information contained in customer regulations, technical manuals/documents, positional handbooks, or other official publications. The copy of this manual provided to the customer will *not* be updated to reflect current data.

Customers using this manual should report errors or omissions, recommendations for improvements, or other comments to MFJ Enterprises, 300 Industrial Park Road, Starkville, MS 39759. Phone: (662) 323-5869; FAX: (662) 323-6551. Business hours: M-F 8-4:30 CST.

Contents

THE BASICS

Introduction	1
Front Panel	2
Back Panel	3
Connecting to a Computer	5
Basic Operation	6
How to Use the Menu System	6

THE MENUS

Main Menu	9
MSG1-MSG4 Buttons	9
MSG5-MSG8 Buttons	9
Command [COM] Button	9
Decrement [DEC] Button	9
Carrier Tune [CXT] Button	9
Pulse Tune [PXT] Button	9
Speed	10
Farnsworth	10
Weight	10
Tone	10
Changing Memory Banks	10
Miscellaneous	10
Setup Menus	11
Speed Ratio	11
Overall Speed	11
Farnsworth	11
CCW Weight	12
CW Weight	12
Character Space	12
Word Space	12
Keying Compensation	13
Keying Delay	13
PTT Hang Time	13
Tone	13
Serial Number	14
Leading Zeroes	14
Other Zeroes	14
Nines	14
Iambic	14
Reverse	15
Paddle	15
Monitor	15
Output	15

Queue	15
User	15

THE PADDLE

Using the MFJ-495 with a Paddle	16
Setup Commands	16
Message Memory	20

THE KEYBOARD

Using the MFJ-495 with a Keyboard	21
Keyboard Key Combinations	21
Setup Commands	23
Message Memory	27
Quick Speeds	28

THE TERMINAL

Using the MFJ-495 with a Terminal Program	29
Setup Commands	29
Message Memory	34
Uploading and Downloading Messages	34
Loading a Memory Block from the Computer	34
Sending Contents of a Memory Block to the Computer	35

THE MEMORY

Message Memory	36
Preparing Messages	37
Embedded Commands	37

APPENDICES

Resetting the Keyer	41
Factory Defaults	41
Message Memory Reset	42
Self Test	42
Power Down Circuit Test	43
Troubleshooting	44
Technical Assistance	44
Morse Code Character Set	45
Signals Used in Other Radio Services	46
Some CW Abbreviations	46
Meaning of Q Signals	47
Setup Commands	48
Schematic	50

FIGURES

Figure 1. MFJ-495 Front Panel	2
Figure 2. MFJ-495 Back Panel	3
Figure 3. Qwerty Keyboard Layout	5
Figure 4. Dvorak Keyboard Layout	5
Figure 5. MFJ-495 Menu Flow and Button Action Chart.....	7
Figure 6. Code Weight.....	12
Figure 7. Keying Delay and PTT Hang Time Timing	13
Figure 8. Rise Time and Decay Time Timing	14
Figure 9. MFJ-495 Message Memory Structure	36

TABLES

Table 1. Keying Output Jumpers	3
Table 2. Manual Key Jumper.....	4
Table 3. Keyboard Jumpers	4
Table 4. Setup Commands	48

THIS PAGE IS LEFT BLANK INTENTIONALLY

The Basics

Introduction

The MFJ-495 Memory Keyer is a full-featured memory keyer combining dual microprocessors and a non-volatile EEPROM chip for a full featured, low cost, high reliability design. Unlike other keyers, it uses a LCD display to set keyer functions and show the sending message. The MFJ-495 keys CW from a paddle, a keyboard and a serial computer interface. All code parameters are changed with an easy to use menu interface shown on the LCD display. The MFJ-495 has 32 message memories total over 8000 characters which can be loaded by paddle, keyboard or from a computer with a terminal program. The MFJ-495 can repeat messages continuously, insert timed pauses within messages, insert an auto-incrementing serial number, have messages call other messages or insert embedded commands into a message. Commands also can be simply sent to the keyer in Morse code using your paddles, keyboard, terminal program on your computer, or push-button switches on the unit.

The MFJ-495 has controls for volume and speed on the front of the unit. The paddle jack connects to any iambic or single lever (dual contact) key paddle. The keyboard port allows use of an optional keyboard for keyboard keying operation. The serial interface allows connection of most RS-232 compatible computers. The MFJ-495 supports both Direct and Grid-Block outputs and has a port for an optional remote control. Some of its features:

- 2-line by 16-character LCD display.
- Iambic keyer with dot and dash memories; automatic, semi-automatic or hand-key mode.
- 32 messages (four banks of eight messages each) total over 8000 characters.
- Messages may “call” other messages and contain programmed functions.
- Message editing capability.
- Input queue to store multiple message activation.
- Auto-incrementing contest serial number from 001 to 9999.
- Digital and linear analog speed control from 5 to 99 WPM (2:1-to-20:1 speed range ratio).
- Farnsworth mode with speed from 10 to 99 WPM.
- Ultra speed mode allows messages at speeds up to 990 WPM.
- QRSS mode allows messages at speeds of QRSS1 to QRSS99.
- Adjustable weight on code elements from 25% to 75% (constant or speed dependent).
- Adjustable sidetone frequency from 300 to 1000 Hz.
- Compensation for transmitter character shortening up to 25 ms.
- Keying output delay up to 20 ms to accommodate switching delay.
- Push-to-talk (PTT) hang time up to 10 seconds.
- Direct (positive) or grid-block (negative) keying.
- Carrier tune and adjustable pulse tune functions for transmitter adjustment.
- Timed pauses within messages and message loop capability for continuous replay.
- Message and keyer configuration saved without battery backup.
- Internal sidetone speaker with adjustable volume.
- Support for Qwerty and Dvorak keyboards with RepeatKey feature.
- 190 characters type-ahead keyboard buffer with buffer-full warning.
- Quad user mode supports four operators with different configuration settings.

Front Panel

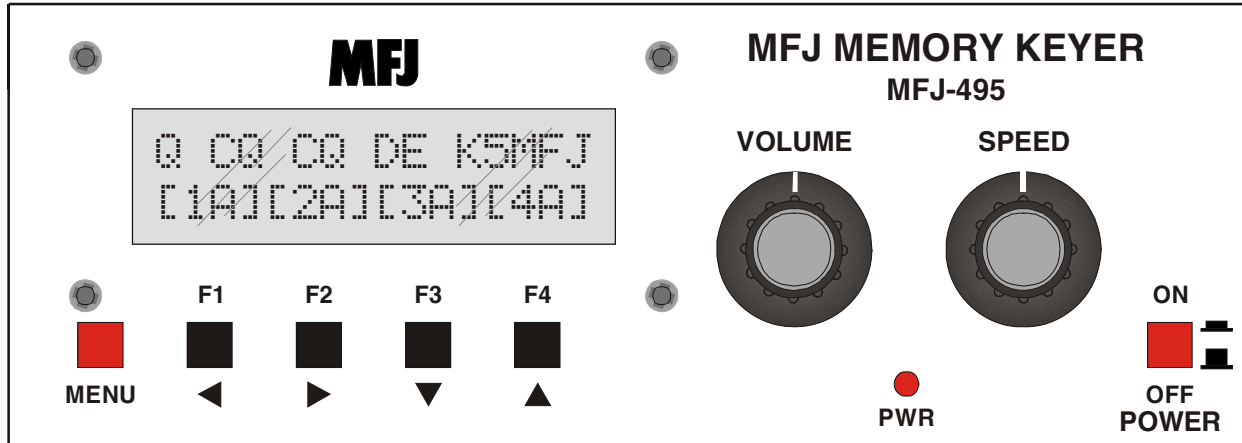

Figure 1. MFJ-495 Front Panel.

- **LCD Display:** A 2-line by 16-character alphanumeric display. It displays the keyer's various menus and the code being sent.
- **Menu Button:** Time-sensitive and used to navigate through the various menus and to enter or exit the setup menus.
- **Function Buttons:** The general purpose Function buttons F1 to F4 perform the operations displayed on the LCD above each corresponding buttons. They also use to navigate through the setup menus as well as to change the keyer settings within the setup menus. These buttons are also time-sensitive.

Note: The F1 to F4 on the MFJ-495 will be referred to as “button” and the F1 to F4 on the keyboard will be referred to as “key” throughout this manual.

- **Volume Control:** Used to adjust the sidetone audio volume to the internal speaker and Audio Out jack. Turn the control clockwise to increase the volume and counter-clockwise to decrease the volume.
- **PWR LED:** Illuminates when the power to the unit is on. It also blinks when the keyer is in message program mode and command mode.
- **Speed Control:** Used to adjust the code speed in a 2:1-to-20:1 ratio within the range of 5 to 99 WPM. Turn the control clockwise to increase speed and counter-clockwise to decrease speed.

Whenever the speed is changed using the front panel Speed control, the LCD momentarily displays the change for approximately two seconds so you can see exactly what speed you just changed to. Also, the Speed main menu is shown momentarily after the power is turned on, and then changes to the last-used main menu.

- **Power Button:** Used to turn the unit on and off. Press to turn power on; press again to turn power off.

WARNING: Do not turn the power on and off rapidly, otherwise the memory (keyer settings) would be corrupted and the unit will have to reset to factory defaults to function properly.

Back Panel

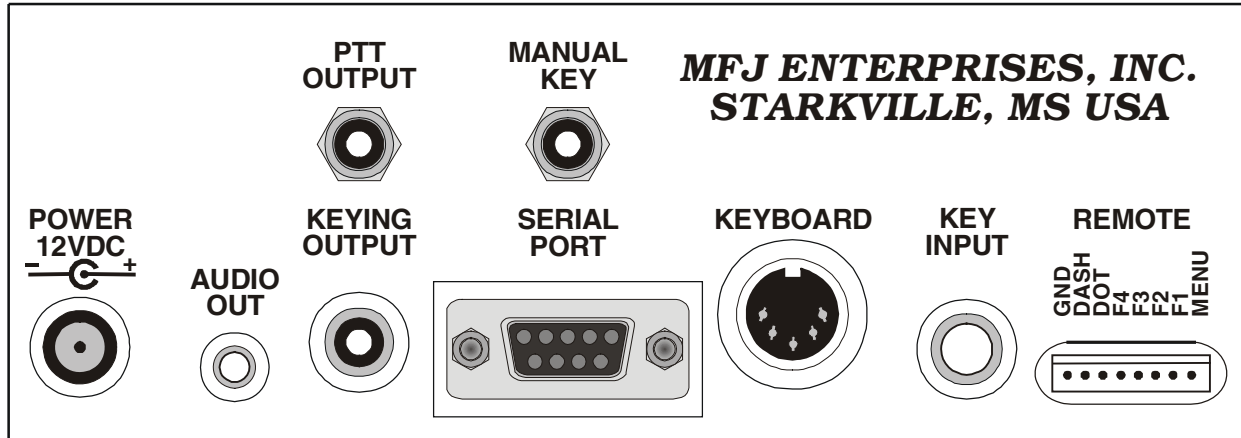

Figure 2. MFJ-495 Back Panel.

- Power:** Accepts a standard 2.1 × 5.5 mm coaxial plug with positive center and negative sleeve. This unit requires 12 volts DC. An optional 500 mA power supply, the MFJ-1315, is available from MFJ Enterprises, Inc. This unit requires a minimum of 50 mA at no volume and without using a keyboard and a maximum of 300 mA at maximum volume into an 8-ohm audio load with a typical keyboard. It may require more current depending on the keyboard used; typical keyboard uses about 100 mA.

WARNING: Do not apply voltages greater than 18 volts to this unit, or permanent damage to the unit may result.

- Audio Out:** A 3.5 mm stereo phone jack for connecting to an external speaker or headphones. This jack accepts both stereo and mono plugs. When this jack is used, the internal speaker is disabled. An optional external speaker, the MFJ-281, is available from MFJ Enterprises, Inc.

WARNING: To prevent suffering hearing damage when using headphones, turn the Volume control to minimum before putting on the headphones and then slowly adjust for a comfortable volume.

- PTT Output:** An RCA jack providing connection for a PTT (push-to-talk) output that goes low when active. This jack is an open-drain output; an external pull-up can be used if so desired. Use a quality-shielded cable for connection to this jack.
- Keying Output:** This unit supports both positive and negative keyed radios. Use a quality-shielded cable for connection to this RCA jack. Consult your transmitter's manual to determine if it uses direct (positive) or grid-block (negative) keying.

Two jumpers JMP1 and JMP2 inside the unit set the keying output to direct for positive keyed radios (most solid-state radios) or to grid-block for negative keyed radios (most

JMP1	JMP2	Keying Output
D	D	Direct *
D	G	Invalid
G	D	Invalid
G	G	Grid Block

Table 1. Keying Output Jumpers.

radios with tube finals). Set both jumpers to the “D” positions for direct keying or to the “G” positions for grid-block keying. If it is set wrong, the transmitter will either not key at all or key continuously. The factory default * is direct keying output.

- Manual Key:** An RCA jack providing an input line for manually keyed devices, such as a straight key or a computer interface. An internal jumper JMP3 configures this jack to accept active-low (for straight key) or active-high (output from computer software) input. Set this jumper to the “L” position for active-low input or to the “H” position for active-high input. If it is set wrong, the keyer will key continuously. The factory default * is active-high.

JMP3	Manual Key
L	Active Low
H	Active High *

Table 2. Manual Key Jumper.

- Serial Port:** Accepts a standard 9-pin serial plug for connecting the MFJ-495 to a computer for ASCII file transfers or monitoring your sending on the computer screen. A 9-pin-to-9-pin serial cable is needed. If your computer has a 25-pin serial port, use a 9-pin-to-25-pin adapter.

To communicate with the MFJ-495, use a terminal program on your computer that is capable of transferring information in ASCII format. Configure the software for 1200 baud, 8 data bits, 1 stop bit and no parity; set the flow control to Xon/Xoff.

- Keyboard:** Accepts most standard AT style keyboards (XT keyboard does not work with the MFJ-495). The MFJ-551 keyboard is guaranteed to be fully compatible with the keyer and available from MFJ Enterprises, Inc.

Two jumpers JMP4 and JMP5 inside the unit configure the keyboard operation. Jumper JMP4 selects whether a Qwerty or Dvorak keyboard is used (see Figures 3 and 4 on next page); place this jumper on the “L” position for the Qwerty keyboard or on the “H” position for the Dvorak keyboard. Jumper JMP5 set the RepeatKey feature that selects whether or not to repeat a key when it is held down; place this jumper on the “L” position to disable RepeatKey or on the “H” position to enable RepeatKey. The factory defaults * are Qwerty keyboard and RepeatKey off.

JMP4		Keyboard Layout
L		Qwerty *
H		Dvorak
	JMP5	RepeatKey
	L	Off *
	H	On

Table 3. Keyboard Jumpers.

- Key Input:** A ¼-inch stereo phone jack for connecting to a paddle. An iambic or single lever (dual contact) paddle with a shielded cable should be used. When used with paddles, the dot wire should be connected to the tip of the plug, the dash wire to the ring, and the ground wire to the shield.
- Remote Port:** The last port on the back of the unit is for the optional remote control. The remote control gives you remote access to the keyer menu if the main unit is out of reach. The remote has the menu and function buttons as well as the paddles connections. The remote connector combines both the remote functions and the paddle jack so that only one cable from the paddle to the keyer is needed.

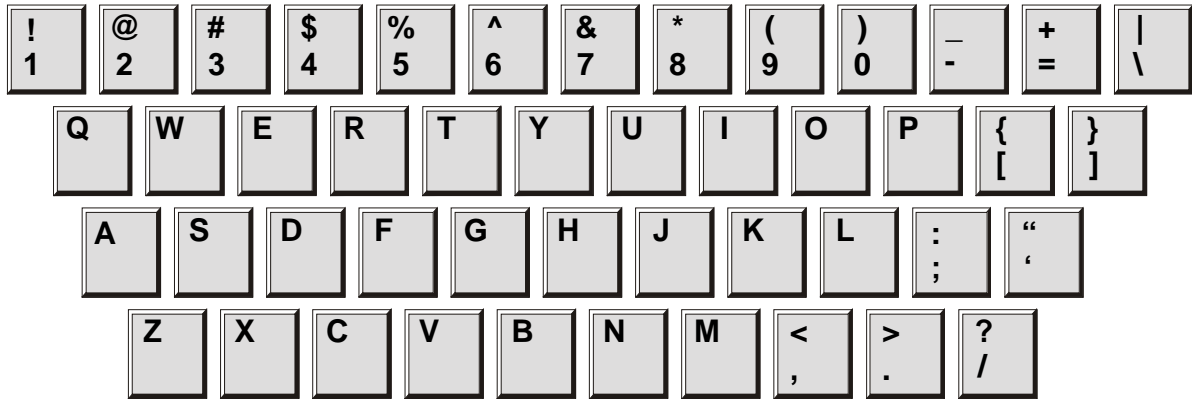

Figure 3. Qwerty Keyboard Layout.

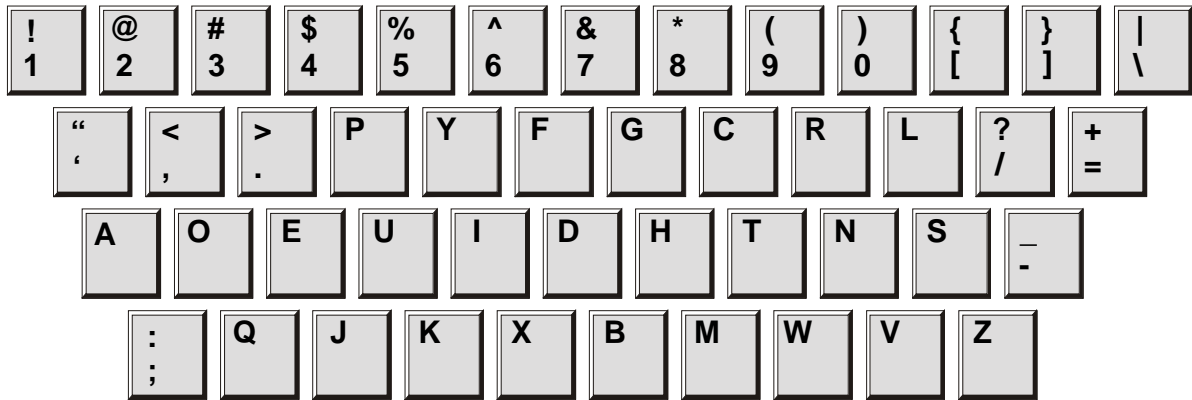

Figure 4. Dvorak Keyboard Layout.

Connecting to a Computer

You may connect the MFJ-495 to a computer using the 9-pin DIN serial port on the back panel. If your computer has a 25-pin serial port, you can use a 25-pin-to-9-pin adapter.

To use a computer with the MFJ-495, run a terminal program that will upload and download ASCII files, and configure the terminal program to do so. Set the terminal program for 1200 baud, 8 data bits, one stop bit and no parity; set the flow control to Xon/Xoff. If you see extraneous linefeeds on the computer screen when receiving data from the MFJ-495, you may configure your software to strip out these extra linefeeds.

During sending, the characters sent by the MFJ-495 are sent through the serial port, so you may use your computer to monitor the transmitted copy. You may find this particularly convenient.

You also may upload and download text files between the MFJ-495 and your computer. For details on this, see the discussion of “Uploading and Downloading Messages” on page 34.

Basic Operation

The Memory Keyer is simple to operate. The Power button controls power to the unit. Start sending with a paddle or keyboard. Adjust the volume and speed to your preference. If the speed is still too fast or too slow, adjust the range of the Speed control using the Speed and Ratio commands.

All characters or code sent by the user are played on the sidetone speaker. This allows the user to hear what he is keying, typing, or sending with a computer. Only when the keyer is used with a paddle is the code sent as soon as it is keyed. When using a keyboard or keyer terminal, you may type ahead of the code that is being transmitted. This allows you to enter words and phrases faster than the transmitted code. This permits smoother code with less pauses because you can fix misspelled words and think of the right phrase to use while your previous sentence is being sent.

When you are in command mode, memory save, or configuration mode, the code sent to the speaker is not sent to the Keying Output or your radio. This keeps all erroneous code off of the air.

How to Use the Menu System

You may set up the MFJ-495 to perform any of its many functions by making the appropriate selections from its menu system. This system consists of seven main menus and 22 setup menus. You make your selections using the five buttons under the LCD display - Menu, F1/Previous ◀, F2/Next ▶, F3/Down ▼, and F4/Up ▲. These buttons do the following:

- Menu - Scrolls through the main and setup menus when press briefly. To enter the setup menu, press and hold this button for two seconds. To exit the setup menu, press and hold this button for two seconds to go back to the main menu.
- F1/Previous - Selects the main menu command or the previous setup menu.
- F2/Next - Selects the main menu command or the next setup menu.
- F3/Down - Selects the main menu command or the previous item in a setup menu.
- F4/Up - Selects the main menu command or the next item in a setup menu.

The main menus are arranged in a "wrap-around" structure, so that momentarily pressing the Menu button will bring up another main menu in a sequence. Figure 5 shows the sequence of the main menus. When power is turned on, the main menu displayed is the one that was displayed when the unit was last turned off.

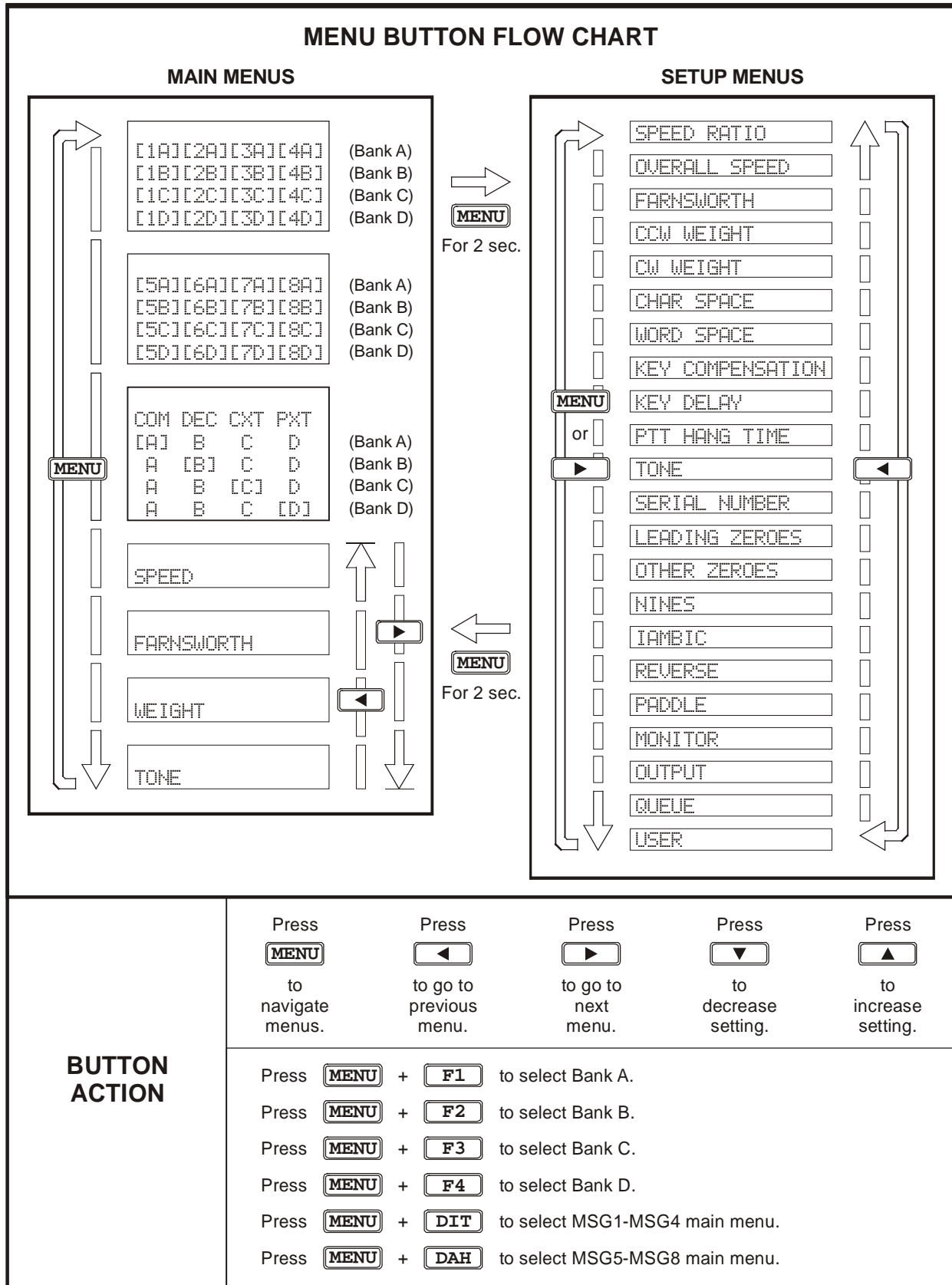

Figure 5. MFJ-495 Menu Flow and Button Action Chart.

The setup menus are also arranged in a "wrap-around" structure, so that pressing the Previous or Next button will bring up another setup menu in a sequence. Also, momentarily pressing the Menu button will bring up the next setup menu. Figure 5 shows the sequence of the setup menus. When entering the setup menus, the setup menu displayed is the one that was last used.

To see how the setup menu system works, consider the following example.

EXAMPLE: To enter the setup menu, press and hold the Menu button for two seconds. If the display shows that you are in the Overall Speed menu, pressing the Next button would put you in the Farnsworth menu and pressing the Previous button would put you in the Speed Ratio menu. Pressing the Down or Up button would lower or raise the overall code speed. Once you have selected the speed you desire, you may leave the setup menu by pressing the Menu button again for two seconds; or press Previous or Next button to go to another setup menu.

Once you have made your choices within the setup menus, they will be saved in non-volatile memory for your next session.

The Menus

Main Menus

The main menus allow you access to the commonly used functions. There are seven main menus arranged in a “wrap-around” structure. When power on, keyer operation starts with the main menu that was last used. The first two main menus (MSG1-MSG4 and MSG5-MSG8) let you play and save messages. The next main menu allows you to enter command mode and tune modes directly as well as decrement the serial number. The last four main menus give you easier access to the frequently adjusted settings and display their current values. For the first three main menus, the four function buttons take on different meanings and perform the operations displayed directly above each button. Within each main menu, press the Menu button briefly to view the next main menu. Press and hold the Menu button for two seconds to enter the setup menus (see below).

MSG1-MSG4 Buttons

This is the first message menu that consists of four messages buttons, where the digit (1-4) is the message number and the letter (A-D) is the current memory bank. For example, [1A] is message number 1 of bank A. To play a message, press and release the corresponding message button. To save a message, press and hold a message button for two seconds until the keyer responds with “GO” (dah-dah-dit dah-dah-dah). You may then key in a message using the paddle, keyboard or terminal. Refer to “The Memory” section on page 36 for explanation of the MFJ-495’s message memory.

MSG5-MSG8 Buttons

This is the second message menu that consists of another four messages buttons, where the digit (5-8) is the message number and the letter (A-D) is the current memory bank. For example, [8D] is message number 8 of bank D. To play a message, press and release the corresponding message button. To save a message, press and hold a message button for two seconds until the keyer responds with “GO” (dah-dah-dit dah-dah-dah). You may then key in a message using the paddle, keyboard or terminal. Refer to “The Memory” section on page 36 for explanation of the MFJ-495’s message memory.

Command [COM] Button

Use to enter the command mode and the keyer will respond with “CO” (dah-di-dah-dit dah-dah-dah). When a valid command is entered, the keyer will respond with “R” (di-dah-dit) when appropriate. If an invalid command is entered, it will respond with an error character (di-di-di-di-di-di-di-dit). See the “The Paddle” section on page 16 for more details on setup commands.

Decrement [DEC] Button

Use to decrement the serial number by one, effectively canceling the automatic increment applied when last played from a message. The decrement function accommodates re-sending the last serial number, as might be needed when a repeat of a contest exchange is requested, or canceling the exchange with a station that proved to be a “dupe”. The unit will echo a “D” (dah-di-dit) for every number that is decremented. Decrement serial number 0001 rolls over to 9999, because the number 0000 is not used.

Carrier Tune [CXT] Button

Use to engage the carrier tune mode. The keyer will key continuously to tune your station. Press any button, paddle or key to exit.

Pulse Tune [PXT] Button

Use to engage the pulse tune mode. The keyer will send a continuous string of pulses to tune your station. The rate (speed of 50 to 99 WPM) and the duty cycle (weight of 1% to 35%) of the pulses can be

adjusted with the function buttons. Press F1 button to decrease speed and F2 button to increase speed. Press F3 button to decrease weight and F4 button to increase weight. Press Menu button, either paddle or the ESC key to exit.

Speed

This menu is placed in the main menus to allow easier access to change the overall speed for the current position of the Speed control in the range of 5 to 99 WPM. The speed shown on the display corresponds to the current position of the Speed control. When `SPEED` is displayed, press the Down button will decrease the overall sending speed and the Up button will increase it. Note that setting the overall speed higher than or equal to the Farnsworth speed will disable Farnsworth spacing.

Whenever the speed is changed using the front panel Speed control, the LCD momentarily displays the change for approximately two seconds so you can see exactly what speed you just changed to. Also, the Speed main menu is shown momentarily after the power is turned on, and then changes to the last-used main menu.

Farnsworth

This menu is placed in the main menus to allow easier access to change the Farnsworth speed in the range of 10 to 99 WPM. When `FARNSWORTH` is displayed, press the Down button will decrease the Farnsworth speed and the Up button will increase it. The Farnsworth speed must be higher than the overall speed. To turn Farnsworth off, reduce the Farnsworth speed to the same speed as the overall speed.

Weight

This menu is placed in the main menu to allow easier access to change the weight of code elements in the range of 25% to 75%. Weight is the duty cycle of a continuous string of dots, which is 50% for perfect code. The weight shown on the display corresponds to the current position of the Speed control. When `WEIGHT` is displayed, press the Down button will decrease the code weight and the Up button will increase it. Notice that adjusting the weight here changes both the CCW Weight and CW Weight to the same percentage, resulting in a constant code weight. A higher weight produces a heavier sound, and a lower weight causes characters to sound lighter. Once set, weight remains constant and independent of the speed. For variable weight that adjusts with the speed, use the CCW Weight and CW Weight setup menus (see below).

Tone

This menu is placed in the main menu to allow easier access to change the audio frequency of the sidetone in the range of 305 to 1006 Hz. When `TONE` is displayed, press the Down button will decrease the sidetone frequency and the Up button will increase it. Most people prefer 700 to 800 Hz sidetone.

Changing Memory Banks

To change the memory banks from any main menu, press and hold the Menu button and then within two seconds press the F1 button for bank A, F2 button for bank B, F3 button for bank C, or F4 button for bank D. The keyer will respond with "BA", "BB", "BC" or "BD" for the selected bank. Each memory bank has eight message memories (see "The Memory" section on page 36 for more details).

Miscellaneous

A shortcut to the message menus from any main menu is to press and hold the Menu button and then within two seconds press the Dit paddle to select the MSG1-MSG4 menu or press the Dah paddle to select the MSG5-MSG8 menu.

During message playback, the third main menu COM DEC CXT FXT will change to [A] [B] [C] [D]. Notice there is only one set of “[” and “]” that indicates the current memory bank. To change to another memory bank during playback, press the corresponding function button.

Setup Menus

The setup menus allow you to set up how the MFJ-495 works and behaviors. There are 22 setup menus arranged in a “wrap-around” structure. To access these setup menus, press and hold the Menu button for two seconds. The setup menu that will display is the one that was last used. When finishing, press and hold the Menu button for two seconds to go back to the main menus for normal operation. The LED will blink to indicate that you are in the setup menus. The Keying Output and PTT Output are also disabled.

Within each setup menu:

- Press the Menu button briefly to view the next setup menu; press and hold the Menu button for two seconds to exit the setup menu and go back to the main menu.
- Press the Next button to view the next setup menu; press the Previous button to view the previous setup menu.
- Press the Up or Down button to change the setting for that setup menu.

Speed Ratio

The Speed Ratio menu is used to set the speed ratio of the Speed control in the range of 2:1 to 20:1. This ratio is the speed at the full clockwise position to that at the full counter-clockwise position. With minimum overall speed of 5 WPM, a ratio of 20:1 will cover the entire speed range of 5 to 99 WPM. Default speed ratio is 3:1 making the Speed control less sensitive and easier to adjust the code speed.

Overall Speed

The Overall Speed menu allows you to set the code speed for the current position of the Speed control in the range of 5 to 99 words per minute (WPM). There are three numbers on line two of the display. The first number is the speed at the full counter-clockwise position of the Speed control; the second number enclosed within “[” and “]” is the speed corresponding to the current position of the Speed control; and the last number is the speed at the full clockwise position of the Speed control. You can also adjust the Speed control to where you want it to match the speed shown on the display.

By "overall" speed, we mean the speed at which the words are sent. A "word" is defined as 50 units of time, and the word "PARIS" is exactly 50 units in length. Therefore, if "PARIS" is sent 13 times in one minute, the sending speed is 13 WPM. Standard Morse code timing defines a dit as one unit of time and a dah as three units of time. Within each character, there is one unit between elements (dits and dahs). Three units separate characters and seven units separate words. Farnsworth spacing (see below) will increase the amount of time between characters and words. Note that setting the overall speed greater than or equal to the Farnsworth speed will disable Farnsworth spacing.

Farnsworth

The Farnsworth menu allows you to disable or enable Farnsworth mode and set the Farnsworth speed (character speed) in the range of 10 to 99 WPM. When Farnsworth mode is enabled, characters (dots, dashes, and intra-character spaces) are sent at the Farnsworth speed, but the spacing between characters and words is increased to produce a slower overall speed. This technique is useful for helping the novice learn the sounds of the code characters and avoid the tendency of counting individual dots and dashes. The Farnsworth speed is always higher than the overall speed. As a result, Farnsworth mode (if enabled) is automatically disabled when the overall speed is changed to one that is greater than or equal to the

current Farnsworth speed. Also, Farnsworth speed cannot be enabled when the overall speed is at its maximum of 99 WPM.

CCW Weight

The CCW Weight menu is used to set the code weight at the counter-clockwise (CCW) position of the Speed control. There are three numbers on line two of the display. The first number enclosed within “[“ and “]” is the CCW weight; the second number is the weight corresponding to the current position of the Speed control; and the last number is the CW weight. Constant weighting is achieved when all three numbers are the same.

Weight is the duty cycle of a continuous string of dots, where 50% for perfect code. A higher weight produces a heavier sound and a lower weight causes characters to sound lighter. Weight can be set to remain constant and independent of speed, or it can be set to vary with the code speed.

CW Weight

The CW Weight menu is used to set the code weight at the clockwise (CW) position of the Speed control. There are three numbers on line two of the display. The first number is the CCW weight; the second number is the weight corresponding to the current position of the Speed control; and the last number enclosed within “[“ and “]” is the CW weight. Constant weighting is achieved when all three numbers are the same.

Weight is the duty cycle of a continuous string of dots, where 50% for perfect code. A higher weight produces a heavier sound and a lower weight causes characters to sound lighter. Weight can be set to remain constant and independent of speed, or it can be set to vary with the code speed.

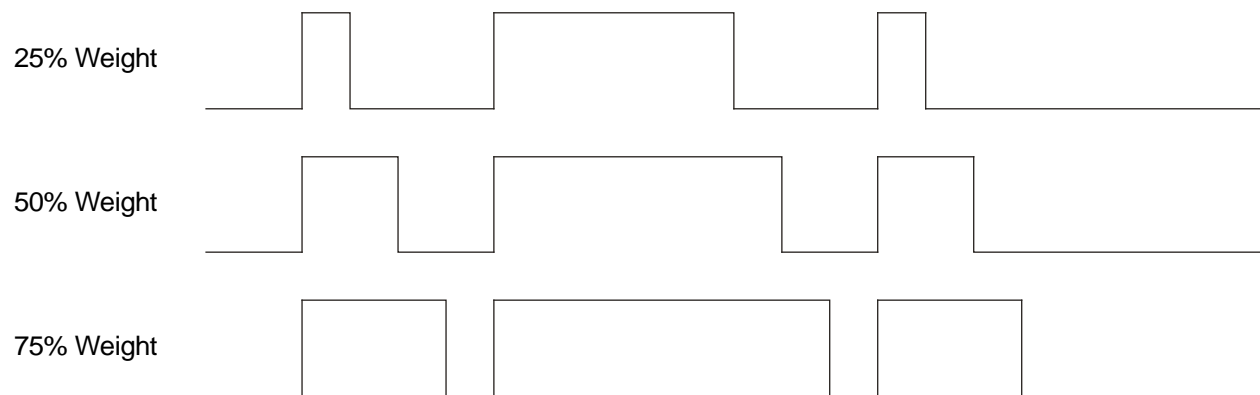

Figure 6. Code Weight.

Character Space

The Character Space menu is used to increase the character space (normally three units) up to 12 units long. There are two numbers on line two of the display; the number enclosed within “[“ and “]” is the character spacing and the other number is the word spacing. Note the character space is always at least four units shorter than the word space. So you might have to increase the word spacing before adjusting the character space.

Word Space

The Word Space menu is used to increase the word space (normally seven units) up to 16 units long. There are two numbers on line two of the display; the number enclosed within “[“ and “]” is the word

spacing and the other number is the character spacing. Note the word space is always at least four units longer than the inter-character space.

Keying Compensation

The Keying Compensation menu is used to increase the keying on-time and decrease the keying off-time up to 25 milliseconds (ms). Some radios have a key delay of 5 ms or more. By setting 5 milliseconds of compensation, the keyer will add 5 ms to the dots and dashes and subtract 5 ms from the intra-character spaces. Although similar to increasing weight, this adjustment is independent of the speed. This setting is used primarily to correct keying distortion by certain transceivers and to eliminate the problems with a transmitter key delay.

Keying Delay

The Keying Delay menu is used to delay the keying output up to 20 milliseconds. This setting is used primarily to accommodate switching delay in certain station setup. It is used in conjunction with the PTT line to delay the keying output until all the switching is finished; that is, the keying output is lagged behind the sidetone audio and the PTT output. This controls the time between when PTT is asserted and when CW keying will start.

PTT Hang Time

The PTT Hang Time menu is used to set the PTT hang time from 1 to 9999 milliseconds. This controls the time between when CW keying is ended and when the PTT will de-assert. You may adjust this to your liking for on-the-air sending. Press the Up and Down buttons to change time in increments of 1 ms; press and hold the Up and Down buttons to change time in increments of 100 ms.

Note: If Keying Delay and PTT Hang Time are equaled to zero, the PTT Output waveform will be identical to the Keying Output waveform.

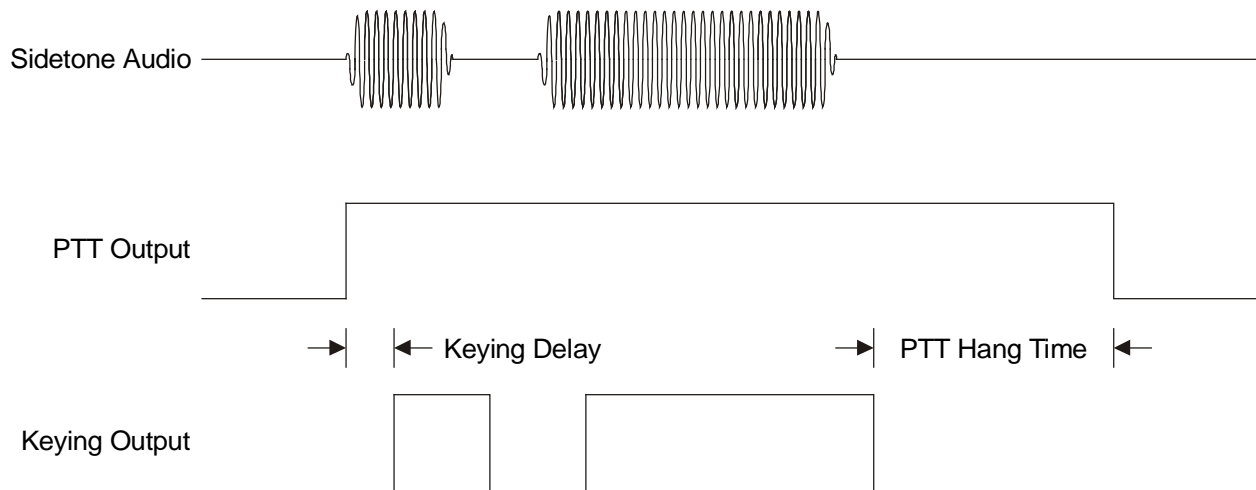

Figure 7. Keying Delay and PTT Hang Time Timing.

Tone

The Tone menu allows you to set the audio frequency in the range of 305 to 1006 Hz. The MFJ-495 features smooth, clean audio, with sine wave output, instead of the harsh square wave audio used by many other keyers. Also, the MFJ-495 produces each dit and dah with a rise and decay time of approximately

5 milliseconds, avoiding the "spikes" that cause distracting key clicks. The MFJ-495's audio sounds like that of a good CW transceiver.

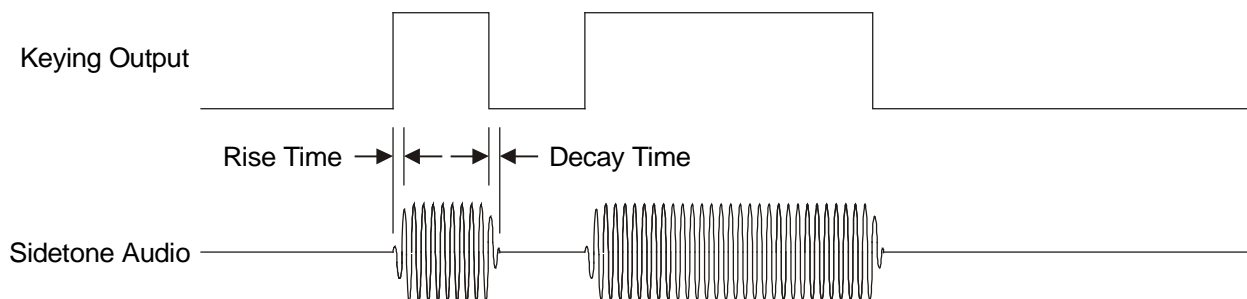

Figure 8. Rise Time and Decay Time Timing.

Serial Number

The Serial Number menu allows you to set the current serial number from 0001 to 9999. Press the Up and Down buttons to change number in increments of 1; press and hold the Up and Down buttons to change number in increments of 100. Only three digits are sent for numbers below 1000—use leading zeroes when appropriate. The serial number is automatically post-incremented each time it is sent. Serial number 9999 will wrap-around to 0001, skipping 0000 since it is not used. Use Leading Zeroes, Other Zeroes and Nines menus to control the way zeroes and nines in the serial number are sent (see below). There are a four-digit number and three single characters on line two of the display. The four-digit number enclosed within “[” and “]” is the serial number.

Leading Zeroes

The Leading Zeroes menu is used to set whether the leading zeroes in the serial number are sent as “0”, “O”, “T” or not at all. There are a four-digit number and three single characters on line two of the display. The character enclosed within “[” and “]” is the replacement for the leading zeroes in the serial number.

Other Zeroes

The Other Zeroes menu is used to set whether the non-leading zeroes in the serial number are sent as “0”, “O” or “T”. There are a four-digit number and three single characters on line two of the display. The character enclosed within “[” and “]” is the replacement for the other zeroes in the serial number.

Nines

The Nines menu is used to set whether the nines in the serial number are sent as “9” or “N”. There are a four-digit number and three single characters on line two of the display. The character enclosed within “[” and “]” is the replacement for the nines in the serial number.

Iambic

The Iambic menu allows you to enable or disable iambic operation. Iambic operation allows you to squeeze both paddles and get alternating dots and dashes. There are two different types of iambic keying, and both are available. The difference in behavior of these two modes occurs when both paddles are squeezed and then released. In iambic A mode, the keyer will simply complete the element (dot or dash) in progress, and then stop sending. In iambic B mode, the keyer will complete the element in progress, and then send an additional opposite element. For example, a release during the dash produces "dit-dah" (A) in iambic A mode but produces "dit-dah-dit" (R) in iambic B mode. Non-iambic mode does not

alternate between dots and dashes during a squeeze. It plays whatever side made contact first until it is released. That is, when iambic mode is disabled there are no dot and dash memories.

Reverse

The Reverse menu allows you to reverse the paddles designation. When using paddles, the MFJ-495 normally expects the dot paddle to be connected to the tip of the plug and the dash paddle to be connected to the plug's ring. If your paddles are wired in the opposite manner, or you wish to change between right and left-handed operators, you may turn Reverse ON to switch the paddle functions. You can also set this mode by simply pressing the paddle you desire to designate as the dot paddle.

Paddle

The Paddle menu allows you to select how the paddle works. With the automatic option, the keyer functions as an iambic keyer for use with a dual-lever paddle. As an iambic keyer, the MFJ-495 has dot and dash memories, for "squeeze keying," and functions just like other iambic keyers, both standalone keyers and those built into radios. With the semi-auto option, the keyer can be used with a single-lever key, with dots generated automatically and dashes formed manually by the user. This emulates the function of a mechanical semi-automatic "bug." You also may use this unit with a straight key or a bug, connect the straight key or bug to the ground and the dash line. With the hand-key option, both the dot and dash lines can be used to connect to a straight key. Notice hand-key mode may not be used to enter messages or setup commands.

Note: In hand-key mode using the paddle, the MFJ-495 will not display the code sent or record to the keyer memory. Also, the difference between this and the Handkey command is that this command affects the paddle only.

Monitor

The Monitor menu is used to toggle the sidetone speaker on and off. If the sidetone is turned off, it will still play command messages and status information. To conserve power, the keyer should be operated with the monitor off in favor of the rig's sidetone.

Output

The Output menu is used to toggle the keying output on and off. If the output is turned off, no signal goes to the Keying Output or the PTT Output to allow practice operation. The output is temporarily disabled during memory message storing, command mode operation, status information, and keyer setup.

Queue

The Queue menu is used to toggle the message queue on and off. Queue mode enables the user to load messages into a buffer to play sequentially. In queue mode, if you press a message button while a message is playing, that message will play after the current message is done. When queue mode is off, pressing a message button will abort any message being played and play the new message. When on, up to 16 button presses are stored in order and acted upon in succession as each message is completed.

Note: Disabling the queue mode increases the message stack size to 24 levels deep used by the embedded Call command.

User

The User menu selects one of four user-configurations to be used as the current setting. This provides support for four operators with different configuration settings, such as speed, weight, etc. This allows up to four operators to use the keyer without having to reconfigure all the settings for each operator. It also supports four different configuration settings for different contest exchanges.

Note: The only thing that is shared among all four users is the message memories.

The Paddle

Using the MFJ-495 with a Paddle

Plug an iambic or single lever paddle into the Key Input jack of the MFJ-495. A ¼-inch stereo phone plug and a two-conductor shielded cable should be used. If separate shielded cables are used, the two shields should be tied together and connected to ground. The dot wire should be connected to the tip of the plug and the dash wire to the ring. Begin sending code using the paddles. If you would like to change speed, sidetone or weight, see the sections pertaining to these commands.

The iambic paddle has a unique feature that the single lever paddle does not have. Notice that the two paddles are independent and can be squeezed together. Both the dot and dash contacts touch the chassis, therefore ground. The MFJ-495 senses this happen and uses it as a separate keying mode.

Iambic keying has two modes: A and B. When a squeeze is released during an element (dot or dash), iambic B adds an opposite element. Iambic A just finishes the element in progress and does not produce a following alternate element.

The dot and dash memories make sending easier. The memories allow the user to key a dot before the completion of a dash and vice versa. This feature can be checked by setting the keyer to the lowest speed and tapping first the dash lever and then the dot lever before the completion of the dash. The keyer will provide both the dash and the dot. The dash memory can be checked in a similar manner. The dot insertion feature allows the user to insert a dot by tapping the dot lever while holding the dash lever in. The dash insertion feature allows the user to insert a dash while holding the dot lever in. The iambic operation allows sending alternate dots and dashes when both levers are squeezed. The first lever contacted will determine whether a dot or dash occurs first.

Note: It is recommended the Farnsworth mode be disabled when sending with the paddle. When Farnsworth mode is enabled, the paddle will send code at the Farnsworth speed, not the overall speed.

Setup Commands

Press the [COM] button and the keyer responds with “CO” (dah-di-dah-dit dah-dah-dah). A tilde character “~” will appear on the display. A setup command can then be entered using your paddle. If the command is invalid then the keyer will send an error character (di-di-di-di-di-di-dit) and return the keyer to normal mode. If the command is valid, the keyer will send an “R” (di-dah-dit). If the user wishes to re-attempt modifying features using command mode, he must re-enter command mode by pressing the [COM] button again. If you enter the command mode accidentally, press the [COM] button at any time to exit. Refer to the appendix “Setup Commands” on page 48 for a table of these commands.

- B#** **Bank** – selects the current memory bank, where # is A, B, C or D. Each memory bank has eight message blocks of 256 characters each, except the last block.
- C#** **Character space** – increases the inter-character space with # standard intra-character spaces, where # is a single digit from 0 to 9. This allows the normally three-unit long inter-character space up to 12 units long. Note the inter-character space is always at least four units shorter than the word space. Therefore, you might have to increase the word spacing before adjusting the character space.

- D** **Decrement** – decrements the serial number by one, effectively canceling the automatic increment applied when last played from a message. The decrement function accommodates re-sending the last serial number, as might be needed when a repeat of a contest exchange is requested, or canceling the exchange with a station that proved to be a “dupe”. The unit will echo a "D" (dah-di-dit) for every number that is decrement. Decrement serial number 0001 rolls over to 9999, because the number 0000 is not used. Alternately, press the [DEC] button also decrements the serial number.
- E##** **Edit** – allows the operator to append onto or edit an existing message memory, where the first # is the message number 1 to 8 and the second # is the bank A to D. The keyer will display your message to the last word. You can then paddle in more text or erase existing words, just like the procedure when loading a message.
- F##** **Farnsworth** – uses to enable Farnsworth mode and spacing. Farnsworth spacing adds more time between characters to slow down the overall sending speed. The advantage of this is that, by hearing the characters sent at a faster speed, you learn to recognize each character by its distinctive rhythm, rather than by trying to "count dits." This greatly assists you in copying Morse code at higher speeds. The Farnsworth speed, however, must be higher than the overall speed. Setting ## to 00 or less than or equal to the overall speed will disable Farnsworth mode.
- Note:** It is recommended the Farnsworth mode be disabled when sending with the paddle. When Farnsworth mode is enabled, the paddle will send code at the Farnsworth speed, not the overall speed.
- G#** **Gap (word space)** – increases the word space with # standard intra-character spaces, where # is a single digit from 0 to 9. This allows the normally seven-unit long word space up to 16 units long. Note the word space is always at least four units longer than the inter-character space.
- H** **Hand key** – enters the hand key mode to use the paddle as a hand (straight) key. Dots and dashes are made manually by using either lever of the paddle. That is, keying follows closure of the dot or dash paddle, allowing hand-sent code. Normal keyer operation is regained by squeezing both paddles.
- I#** **Iambic** – enables iambic mode A or B where # represents A or B, or disables iambic operation with # = N.
- J####** **PTT hang time** – sets the PTT (push-to-talk) hang time to #### millisecond, where #### represents four digits in the range of 0001 to 9999. This controls the time between when CW keying is ended and when the PTT will de-assert. You may adjust this to your liking for on-the-air sending.
- K##** **Keying compensation** – sets the keying compensation to ## millisecond, where ## represents two digits in the range of 00 to 25. Some radios have a key delay of 5 ms or more. By entering K05, the keyer will add 5 ms to the dots and dashes and subtract 5 ms from the intra-character spaces. Although similar to increasing weight, this adjustment is independent of the speed. This setting is used primarily to correct keying distortion by certain transceivers and to eliminate the problems with a transmitter key delay.
- L##** **Lag (keying delay)** – sets the keying delay to ## millisecond, where ## represents two digits in the range of 00 to 20. This setting is used primarily to accommodate switching delay in certain station setup. It is used in conjunction with the PTT line to delay the keying output until all the switching is finished; that is, the keying output is lagged behind the sidetone

audio and the PTT output. This controls the time between when PTT is asserted and when CW keying will start.

- M#** **Monitor** – enables ($\# = Y$) or disables ($\# = N$) the sidetone monitor, or toggles the sidetone monitor on or off without keying the #. If the sidetone is turned off, it will still play command messages and status information. To conserve power, the keyer should be operated with the monitor off in favor of the rig's sidetone.
- N####** **Number** – sets the serial number. You must enter four numbers, most significant digit first. All numbers must be in the proper Morse code format. For example, the number "1" must be "di-dah-dah-dah-dah" and the number "0" must be "dah-dah-dah-dah-dah". The serial number can be set from 0000 to 9999 (0000 will be converted to 0001).
- O#** **Output** – enables ($\# = Y$) or disables ($\# = N$) the keying output, or toggles the keying output on or off without keying the #. If the output is turned off, no signal goes to the Keying Output or the PTT Output to allow practice operation. The output is temporarily disabled during memory message storing, command mode operation, status information, and keyer setup.
- P#** **Paddle** – selects paddle mode of automatic ($\# = A$), semi-automatic (bug, $\# = S$) or hand-key ($\# = H$) mode. With the automatic option, the keyer functions as an iambic keyer for use with a dual-lever paddle. As an iambic keyer, the MFJ-495 has dot and dash memories for "squeeze keying" and functions just like other iambic keyers, both standalone keyers and those built into radios. With semi-auto option, the keyer can be used with a single-lever key, with dots generated automatically and dashes formed manually by the user. This emulates the function of a mechanical semi-automatic "bug." You also may use this unit with a straight key or a bug, connect the straight key or bug to the ground and the dash line. With the hand-key option, both the dot and dash lines can be used to connect to a straight key. Notice hand-key mode may not be used to enter messages or commands.

Note: In hand-key mode using the paddle, the MFJ-495 will not display the code sent or record to the keyer memory. Also, the difference between this and the Hand-key command is that this command affects the paddle only.

- Q#** **Queue** – enables ($\# = Y$) or disables ($\# = N$) the message queue, or toggles the message queue on or off without keying in #. Queue mode enables the user to load messages into a buffer to play sequentially. In queue mode, if you press a message button while a message is playing, that message will play after the current message is done. When queue mode is off, pressing a message button will abort any message being played and play the new message. When on, up to 16 button presses are stored in order and acted upon in succession as each message is completed.

Note: Disabling the queue mode increases the message stack size to 24 levels deep used by the embedded Call command.

- R##** **Ratio** – sets the speed ratio of the Speed control, where ## represents two digits in the range of 02 to 20. The speed at the full clockwise position of the control is ## times that of the speed at the full counter-clockwise position.
- S##** **Speed** – sets the overall code speed to ## WPM, where ## represents two digits in the range of 05 to 99. By "overall" speed, we mean the speed at which the words or groups are sent. A "word" is defined as 50 units of time, and the word "PARIS" is exactly 50 units in length. Therefore, if "PARIS" is sent 13 times in one minute, the sending speed is 13 wpm.

Standard Morse code timing defines a dit as one unit of time and a dah as three units of time. Within each character, there is one unit between elements (dits and dahs). Three units

- separate characters and seven units separate words. Farnsworth spacing (see above) will increase the amount of time between characters and words. Note that setting the overall speed greater than or equal to the Farnsworth speed will disable Farnsworth spacing.
- T##** **Tone** – sets the sidetone frequency to approximately ##0 Hz, where ## represents two digits in the range of 30 to 99. The MFJ-495 features smooth, clean audio, with sine wave output, instead of the harsh square wave audio used by many other keyers. Also, the MFJ-495 produces each dit and dah with a rise and decay time of approximately 5 milliseconds, avoiding the "spikes" that cause distracting key clicks. The MFJ-495's audio sounds like that of a good CW transceiver.
- T** **Tone** – sets the sidetone frequency in the range of approximately 300 to 1000 Hz. Press the dash paddle to raise the sidetone frequency; press the dot paddle to lower. Squeeze both paddles to exit. Notice an alternating series of dots and dashes are sent to the sidetone monitor to assist in the setting of the desired sidetone frequency.
- U#** **User** – selects the current user, where # represents the digit 1 to 4. User mode is provided to support four operators with different configuration settings, such as speed, weight, etc. This allows up to four operators to use the keyer without having to reconfigure all the settings for each operator. It also supports four different configuration settings for different contest exchanges.
- V** **reVerse** – reverses the sense of the dot and dash paddles. When using paddles, the MFJ-495 normally expects the dot paddle to be connected to the tip of the plug and the dash paddle to be connected to the plug's ring. If your paddles are wired in the opposite manner, or you wish to change between right and left-handed operators, you may reverse the paddles.
- W####** **Weight** – sets the automatic code weighting between ## percent at the counter-clockwise position and ## percent at the clockwise position of the Speed control, where each ## represents two digits in the range of 25 to 75. Weighting varies linearly with the overall speed (automatic weight). Set both ## to the same value for constant weight, where weighting is independent of the overall speed.
- Weight is the duty cycle of a continuous string of dots, where 50% for perfect code. A higher weight produces a heavier sound and a lower weight causes characters to sound lighter. Weight can be set to remain constant and independent of speed, or it can be set to vary with the code speed.
- X** **Xmit (carrier tune)** – gives continuous key-down for adjusting transmitter or antenna tuner. Tap either paddle to exit and release the key line.
- Y** **Pulse tune** – gives continuous adjustable pulses for adjusting transmitter or antenna tuner. Press F1 and F2 buttons to change the speed in the range of 50 to 99 WPM. Press F3 and F4 buttons to change the weight (duty cycle) in the range of 1% to 35%. Tap either paddle to exit and release the key line.
- Z###** **Zeros and nines** – sets the way zeros and nines in the serial number are sent. The first # sets whether to send the leading zeros as "0", "O", "T" or not at all by setting # to "N". The second # sets whether the other zeros are sent as "0", "O" or "T". The last # sets whether the nines are sent as "9" or "N". For example, "ZO09" will send the leading zeros as "O" (dah-dah-dah), the other zeros as "0" (dah-dah-dah-dah-dah), and the nines as "9" (dah-dah-dah-dah-dit).

Message Memory

To play or save to a message memory, select the correct bank by pressing the Menu button together with a function button. To play a message, press and release the corresponding message button (1 - 8). The message will play and send to your radio. To save a message to memory, press and hold a message button for two seconds until the keyer plays "GO" (dah-dah-dit dah-dah-dah) in Morse code. You may now key in a message using the paddle.

Begin keying your message. As you pause after every word, the keyer will insert a word break. If the keyer does not recognize your code as a valid character, the keyer will display a block character and that character will not be saved. Continue keying in the rest of the word.

If you make a mistake entering a word, you can back up over it by keying in at least 10 continuous dots. The keyer will erase the previous word. Also, press the Menu button momentarily will delete the last character; press and hold the Menu button for two seconds will delete the last word.

At the end of your message, press and hold any of the four message buttons for two seconds to end your message. The keyer will respond by sending an end-of-message character (di-dah-di-dah-dit) and automatically insert "]" to the end of your message.

Refer to "The Memory" section on page 36 for explanation of the MFJ-495's message memory and how to use the embedded commands to enhance your message.

The Keyboard

Using the MFJ-495 with a Keyboard

When you plug in a standard IBM style AT keyboard, your keyer becomes a powerful keyboard keyer. The MFJ-495 uses the letter keys A-Z, the number keys 0-9, the function keys F1-F12, the space bar, the arrow keys, and the punctuation characters that have Morse equivalents. Prosigns have been assigned to some of the other punctuation characters for quick operation. See the appendix “Morse Code Character Set” on page 45.

The operation of the keyboard is simple. Begin typing on the keyboard. Typed characters are sent at the code speed of the keyer. If a typing mistake occurs, the BACK SPACE key can be pressed to erase the last character *before* it is sent. If you want to purge all the text in the buffer that has not yet been sent, press the ESC key. Pressing PAUSE during transmission stops playback of the buffer text and allows entry with the paddle; press ESC *once* resumes playback of the buffer text from where it was interrupted (pressing ESC *twice* will abort the message playback).

When typing speed is greater than the code speed, characters will begin to fill a type-ahead buffer. The code sent to the radio and over the sidetone speaker will lag behind the typing of each character. Most of the time this will not cause a problem. Only for very fast typists that send slow code will the type-ahead buffer fill significantly. The maximum size of the type-ahead buffer is 190 characters. When the buffer fills to 180 characters, the sidetone will be higher. This is a signal to slow typing speed because when the buffer fills to 190 characters each new key-press will be lost. It is best to never type much faster than your code speed.

Transmitted characters and type-ahead buffer memory may be monitored using the LCD display on the MFJ-495. This readout is comprised of two lines of text, each containing 16 characters. The top line shows the characters currently being transmitted. The bottom line shows the content of the type-ahead buffer memory; this buffer line is toggled on and off with the PRINT SCREEN key. Note that non-ASCII characters, such as CTRL, ALT, SHIFT, etc., are displayed as a block character on the buffer line.

If you want to send a special prosign, you can enclose it in “<” and “>”. To make a special prosign, begin the prosign with “<”, type the characters of the prosign, and end the prosign with “>”. For example, to make the prosign SN types <SN>. This will remove the inter-character spaces between the characters making it a prosign. Any prosign can be made this way, even special local prosigns. Another method is to enclose the prosign with backslashes such as \SN\. An easier way to send special prosign is press ALT key, type the characters of the prosign, and then release the ALT key (this method does not work within the terminal program as the ALT key is reserved for other functions).

Note: The open angle bracket “<” enables prosign mode and the close angle bracket “>” disables prosign mode; while the backslash “\” toggles the prosign mode on and off. In addition, pressing the ALT key enables prosign mode and releasing disables it. A word space also disables prosign mode.

Keyboard Key Combinations

Press a modifier key (CTRL, ALT or SHIFT) in combination with another key to perform special functions or shortcuts. Note that these key combinations do not work in the Terminal mode, because these modifier keys are reserved for the computer uses.

Key	Normal	Shift	Alt	Ctrl
A	a	A	Custom Prosign	
B	b	B	Custom Prosign	Set Bank
C	c	C	Custom Prosign	Set Character Space
D	d	D	Custom Prosign	Decrement Number
E	e	E	Custom Prosign	Edit Message
F	f	F	Custom Prosign	Set Farnsworth
G	g	G	Custom Prosign	Set Word Space (Gap)
H	h	H	Custom Prosign	Hand Key
I	i	I	Custom Prosign	Set Iambic
J	j	J	Custom Prosign	Set Hang Time
K	k	K	Custom Prosign	Set Key Compensation
L	l	L	Custom Prosign	Set Key Delay (Lag)
M	m	M	Custom Prosign	Set Monitor
N	n	N	Custom Prosign	Set Number
O	o	O	Custom Prosign	Set Output
P	p	P	Custom Prosign	Set Paddle
Q	q	Q	Custom Prosign	Set Queue
R	r	R	Custom Prosign	Set Ratio
S	s	S	Custom Prosign	Set Speed
T	t	T	Custom Prosign	Set Tone
U	u	U	Custom Prosign	Set User
V	v	V	Custom Prosign	Reverse
W	w	W	Custom Prosign	Set Weights
X	x	X	Custom Prosign	Carrier Tune (Xmit)
Y	y	Y	Custom Prosign	Pulse Tune
Z	z	Z	Custom Prosign	Set Zeroes & Nines
F1	Play Message 1		Select User 1	Program Message 1
F2	Play Message 2		Select User 2	Program Message 2
F3	Play Message 3		Select User 3	Program Message 3
F4	Play Message 4		Select User 4	Program Message 4
F5	Play Message 5		Toggle Monitor	Program Message 5
F6	Play Message 6		Toggle Output	Program Message 6
F7	Play Message 7		Toggle Queue	Program Message 7
F8	Play Message 8		Enter Carrier Tune	Program Message 8
F9	Select Bank A		Get Quick Speed 1	Set Quick Speed 1
F10	Select Bank B		Get Quick Speed 2	Set Quick Speed 2
F11	Select Bank C		Get Quick Speed 3	Set Quick Speed 3
F12	Select Bank D		Get Quick Speed 4	Set Quick Speed 4
← LEFT	Decrease Setting	Tone -1 Step	Weight -1%	Speed -1 WPM
→ RIGHT	Increase Setting	Tone +1 Step	Weight +1%	Speed +1 WPM
↓ DOWN	Decrease Setting	Tone -5 Step	Weight -5%	Speed -5 WPM
↑ UP	Increase Setting	Tone +5 Step	Weight +5%	Speed +5 WPM
ESC	Abort/Cancel/Exit			
BACK SPACE	Delete Character			Delete Word
ENTER	End Message			
PRINT SCREEN	Display Type-Ahead			
PAUSE	Pause			
~	Enter setup command mode			
\	Toggle prosign mode			
<	Enable prosign mode or Decrease setting			
>	Disable prosign mode or Increase setting			
-	Decrease setting			
+ or =	Increase setting			
[Use the close square bracket "]" to end message allowing carriage returns in messages			
]	End message if selected by the open square bracket "["			

Note: The ↑ (UP), ↓ (DOWN), ← (LEFT), and → (RIGHT) keys are referred to as the Arrow keys in this manual.

Setup Commands

Press the tilde “~” key to enter command mode and the keyer responds with “CO” (dah-di-dah-dit dah-dah-dah). Enter a setup command. If the command is invalid then the keyer will send an error character (di-di-di-di-di-di-di-dit) and return the keyer to normal mode. If the user wishes to re-attempt modifying features using command mode, he must re-enter command mode by pressing “~” key again. If you enter the command mode accidentally, press ESC key to exit. At any time, press ENTER to accept and exit or press ESC to cancel and exit. Alternately, pressing CTRL+Key to directly enter the command mode; that is, CTRL+S is the same as “~S”. To perform this action, press and hold the CTRL key, press a letter key B to Z, and then release the CTRL key. Refer to the appendix “Setup Commands” on page 48 for a table of these commands.

B# **Bank** – selects the current memory bank, where # is A, B, C or D. Each memory bank has eight message blocks of 256 characters each, except the last block. Alternately, press F9 to select bank A, F10 for bank B, F11 for bank C, and F12 for bank D.

C# **Character space** – increases the inter-character space with # standard intra-character spaces, where # is a single digit from 0 to 9. This allows the normally three-unit long inter-character space up to 12 units long. Note the inter-character space is always at least four units shorter than the word space. Therefore, you might have to increase the word spacing before adjusting the character space.

Press LEFT or DOWN to decrease or press RIGHT or UP to increase the character spacing, or enter one digit 0 to 9 to set the character spacing. Press ENTER to accept and exit, or press ESC to cancel and exit.

D **Decrement** – decrements the serial number by one, effectively canceling the automatic increment applied when last played from a message. The decrement function accommodates re-sending the last serial number, as might be needed when a repeat of a contest exchange is requested, or canceling the exchange with a station that proved to be a “dupe”. The unit will echo a "D" (dah-di-dit) for every number that is decrement. Decrement serial number 0001 rolls over to 9999, because the number 0000 is not used.

E## **Edit** – allows the operator to append onto or edit an existing message memory, where the first # is the message number 1 to 8 and the second # is the bank A to D. The keyer will display your message to the last word. You can then enter more text or erase existing words, just like the procedure when loading a message.

F## **Farnsworth** – uses to enable Farnsworth mode and spacing. Farnsworth spacing adds more time between characters to slow down the overall sending speed. The advantage of this is that, by hearing the characters sent at a faster speed, you learn to recognize each character by its distinctive rhythm, rather than by trying to "count dits." This greatly assists you in copying Morse code at higher speeds. The Farnsworth speed, however, must be higher than the overall speed. Setting ## to 00 or less than or equal to the overall speed will disable Farnsworth mode.

Press LEFT or DOWN to decrease or press RIGHT or UP to increase the speed, or enter two digits 10 to 99 to set the Farnsworth speed or 00 to turn off Farnsworth mode. Press ENTER to accept and exit, or press ESC to cancel and exit

Note: It is recommended the Farnsworth mode be disabled when sending with the paddle. When Farnsworth mode is enabled, the paddle will send code at the Farnsworth speed, not the overall speed.

- G#** **Gap** (word space) – increases the word space with # standard intra-character spaces, where # is a single digit from 0 to 9. This allows the normally seven-unit long word space up to 16 units long. Note the word space is always at least four units longer than the inter-character space.
- Press LEFT or DOWN to decrease or press RIGHT or UP to increase the word spacing, or enter one digit 0 to 9 to set the word spacing. Press ENTER to accept and exit, or press ESC to cancel and exit.
- H** **Hand key** – enters the hand key mode to use the SPACE key as a hand (straight) key. The keyer responds with "HK" (di-di-di-dit dah-di-dah). Dots and dashes are made manually by using the space bar on your keyboard. That is, keying follows closure of the dot or dash paddle or the SPACE key, allowing hand-sent code. Normal keyer operation is regained by squeezing both paddles or by pressing the ESC key.
- I#** **Iambic** – enables iambic A or B mode where # represents A or B, or disables iambic operation with # = N. The keyer will respond with "A" (di-dah), "B" (dah-di-di-dit), or "OFF" (dah-dah-dah di-di-dah-dit di-di-dah-dit). Press ESC to cancel and exit.
- J####** **PTT hang time** – sets the PTT (push-to-talk) hang time to #### millisecond, where #### represents four digits in the range of 0001 to 9999. This controls the time between when CW keying is ended and when the PTT will de-assert. You may adjust this to your liking for on-the-air sending.
- Press LEFT or DOWN to decrease or press RIGHT or UP to increase the hang time, or enter up to four digits 0001 to 9999 to set the hang time. Press ENTER to accept and exit, or press ESC to cancel and exit.
- K##** **Keying compensation** – sets the keying compensation to ## millisecond, where ## represents two digits in the range of 00 to 25. Some radios have a key delay of 5 ms or more. By entering K05, the keyer will add 5 ms to the dots and dashes and subtract 5 ms from the intra-character spaces. Although similar to increasing weight, this adjustment is independent of the speed. This setting is used primarily to correct keying distortion by certain transceivers and to eliminate the problems with a transmitter key delay.
- Press LEFT or DOWN to decrease or press RIGHT or UP to increase the compensation, or enter up to two digits 00 to 25 to set the compensation time. Press ENTER to accept and exit, or press ESC to cancel and exit.
- L##** **Lag** (keying delay) – sets the keying delay to ## millisecond, where ## represents two digits in the range of 00 to 20. This setting is used primarily to accommodate switching delay in certain station setup. It is used in conjunction with the PTT line to delay the keying output until all the switching is finished; that is, the keying output is lagged behind the sidetone audio and the PTT output. This controls the time between when PTT is asserted and when CW keying will start.
- Press LEFT or DOWN to decrease or press RIGHT or UP to increase the delay, or enter up to two digits 00 to 20 to set the delay time. Press ENTER to accept and exit, or press ESC to cancel and exit.
- M#** **Monitor** – enables (#=Y) or disables (#=N) the sidetone monitor, or toggles the sidetone monitor on or off without the #. If the sidetone is turned off, it will still play command

messages and status information. To conserve power, the keyer should be operated with the monitor off in favor of the rig's sidetone.

To change Monitor mode type “~M” followed by “Y” for on, “N” for off, or ENTER to toggle. The keyer will respond with “ON” or “OFF”. Press ESC or any other key to cancel and exit. Also, press ALT+F5 to toggle monitor on/off.

N#### Number – sets the serial number. The serial number can be set from 0000 to 9999 (0000 will be converted to 0001). Enter up to four digits to set the current serial number and press ENTER to accept and exit, or press ESC to cancel and exit.

O# Output – enables (#=Y) or disables (#=N) the keying output, or toggles the keying output on or off without the #. If the output is turned off, no signal goes to the Keying Output or the PTT Output to allow practice operation. The output is temporarily disabled during memory message storing, command mode operation, status information, and keyer setup.

To change Output mode type “~O” followed by “Y” for on, “N” for off, or ENTER to toggle. The keyer will respond with “ON” or “OFF”. Press ESC or any other key to cancel and exit. Alternately, press ALT+F6 to toggle output on/off.

P# Paddle – selects paddle mode of automatic (#=A), semi-automatic (bug, #=S) or hand-key (#=H) mode. With the automatic option, the keyer functions as an iambic keyer for use with a dual-lever paddle. As an iambic keyer, the MFJ-495 has dot and dash memories for "squeeze keying" and functions just like other iambic keyers, both standalone keyers and those built into radios. With semi-auto, the keyer can be used with a single-lever key, with dots generated automatically and dashes formed manually by the user. This emulates the function of a mechanical semi-automatic "bug." You also may use this unit with a straight key or a bug, connect the straight key or bug to the ground and the dash line. With the hand-key option, both the dot and dash lines can be used to connect to a straight key. Notice hand-key mode may not be used to enter messages or commands.

Note: In hand-key mode using the paddle, the MFJ-495 will not display the code sent or record to the keyer memory. Also, the difference between this and the Hand-key command is that this command affects the paddle only.

Q# Queue – enables (#=Y) or disables (#=N) the message queue, or toggles the message queue on or off without the #. Queue mode enables the user to load messages into a buffer to play sequentially. In queue mode, if you press a message button while a message is playing, that message will play after the current message is done. When queue mode is off, pressing a message button will abort any message being played and play the new message. When on, up to 16 button presses are stored in order and acted upon in succession as each message is completed.

To change Queue mode type “~Q” followed by “Y” for on, “N” for off, or ENTER to toggle. The keyer will respond with “ON” or “OFF”. Press ESC or any other key to cancel and exit. Alternately, press ALT+F7 to toggle queue on/off.

Note: Disabling the queue mode increases the message stack size to 24 levels deep used by the embedded Call command.

R## Ratio – sets the speed ratio of the Speed control, where ## represents two digits in the range of 02 to 20. The speed at the full clockwise position of the control is ## times that of the speed at the full counter-clockwise position.

- Press LEFT or DOWN to decrease or press RIGHT or UP to increase the ratio, or enter up to two digits 02 to 20 to set the speed ratio. Press ENTER to accept and exit, or press ESC to cancel and exit.
- S##** Speed – sets the overall code speed to ## WPM, where ## represents two digits in the range of 05 to 99. By "overall" speed, we mean the speed at which the words or groups are sent. A "word" is defined as 50 units of time, and the word "PARIS" is exactly 50 units in length. Therefore, if "PARIS" is sent 13 times in one minute, the sending speed is 13 wpm.
- Standard Morse code timing defines a dit as one unit of time and a dah as three units of time. Within each character, there is one unit between elements (dits and dahs). Three units separate characters and seven units separate words. Farnsworth spacing (see above) will increase the amount of time between characters and words. Note that setting the overall speed greater than or equal to the Farnsworth speed will disable Farnsworth spacing.
- Press LEFT or DOWN to decrease or press RIGHT or UP to increase the code speed, or enter up to two digits 05 to 99 to set the code speed. Press ENTER to accept and exit, or press ESC to accept and exit.
- T##** Tone – sets the sidetone frequency to approximately ##0 Hz, where ## represents two digits in the range of 30 to 99. The MFJ-495 features smooth, clean audio, with sine wave output, instead of the harsh square wave audio used by many other keyers. Also, the MFJ-495 produces each dit and dah with a rise and decay time of approximately five milliseconds, avoiding the "spikes" that cause distracting key clicks. The MFJ-495's audio sounds like that of a good CW transceiver.
- Notice an alternating series of dots and dashes are sent to the sidetone monitor to assist in the setting of the desired sidetone frequency. Press LEFT or DOWN to decrease or press RIGHT or UP to increase the tone frequency, or enter two digits 30 to 99 to set the tone frequency. Press ENTER to accept and exit, or press ESC to cancel and exit.
- U#** User – selects the current user, where # represents the digit 1 to 4. User mode is provided to support four operators with different configuration settings, such as speed, weight, etc. This allows up to four operators to use the keyer without having to reconfigure all the settings for each operator. It also supports four different configuration settings for different contest exchanges.
- Alternately, press ALT+F1 to select user 1, ALT+F2 for user 2, ALT+F3 for user 3, or ALT+F4 for user 4.
- V** reVerse – reverses the sense of the dot and dash paddles. When using paddles, the MFJ-495 normally expects the dot paddle to be connected to the tip of the plug and the dash paddle to be connected to the plug's ring. If your paddles are wired in the opposite manner, or you wish to change between right and left-handed operators, you may reverse the paddles.
- W####** Weight – sets the automatic code weighting between ## percent at the counter-clockwise position and ## percent at the clockwise position of the Speed control, where each ## represents two digits in the range of 25 to 75. Weighting varies linearly with the overall speed (automatic weight). Set both ## to the same value for constant weight, where weighting is independent of the overall speed.
- Weight is the duty cycle of a continuous string of dots, where 50% for perfect code. A higher weight produces a heavier sound and a lower weight causes characters to sound lighter. Weight can be set to remain constant and independent of speed, or it can be set to vary with the code speed.

An alternating dot/dash is produced to aid in changing the weight. Press LEFT or DOWN to decrease or press RIGHT or UP to increase *constant* weight, or enter two pairs of two digits 25 to 75 to set automatic *linear* weight. Press ENTER to accept and exit, or press ESC to cancel and exit.

Tip: Type "W##" and then press TAB or ENTER to change only the counter-clockwise position weight. Type W, press TAB, and then type ## to change only the clockwise position weight

- X **Xmit** (carrier tune) – gives continuous key-down for adjusting transmitter or antenna tuner. Press any key to exit and release the key line. Alternately, press ALT+F8 to activate carrier tune mode.
- Y **Pulse tune** – gives continuous adjustable pulses for adjusting transmitter or antenna tuner. Press F1 and F2 buttons to change the speed in the range of 50 to 99 WPM. Press F3 and F4 buttons to change the weight (duty cycle) in the range of 1% to 35%. Press ESC to exit and release the key line.
- Alternately, use CTRL+Arrow keys to change the pulse speed and ALT+Arrow keys to change the pulse weight.
- Z### **Zeros and nines** – sets the way zeros and nines in the serial number are sent. The first # sets whether to send the leading zeros as "0", "O", "T" or not at all (# = "N"). The second # sets whether the other zeros are sent as "0", "O" or "T". The last # sets whether the nines are sent as "9" or "N". For example, "ZO09" will send the leading zeros as "O" (dah-dah-dah), the other zeros as "0" (dah-dah-dah-dah-dah), and the nines as "9" (dah-dah-dah-dah-dit).
- ## **Play message** – play message ## where the first # is the message number 1 to 8 and the second # is the memory bank A to D. Alternately, press F1 to F8 to play messages in the current memory bank. Press F9 to F12 to select the current memory bank.
- >## **Save message** – save message into the keyer memory ##, where the first # is the message number 1 to 8 and the second # is the memory bank A to D. Alternately, press CTRL+F1 to CTRL+F8 to save messages in the current memory bank. Press F9 to F12 to select the current memory bank.
- <## **View message** – view message ## where the first # is the message number 1 to 8 and the second # is the memory bank A to D.

Message Memory

With the keyboard, you can play or save messages using the keyboard function keys. Press function keys F9 to F12 to quickly select the correct memory bank A to D, respectively. To play a message, press any keyboard function key F1 to F8. The message will play and send to your radio. Press CTRL+Arrow keys to change the overall speed on the fly, press ALT+Arrow keys to change the weight on the fly, and press SHIFT+Arrow keys to change the tone on the fly.

To save a message to memory, press and hold the CTRL key, press the keyboard function key F1 to F8, and then release the CTRL key (this is denoted as CTRL+Fn). The keyer will respond with "GO" (dah-dah-dit dah-dah-dah). Now a message can be typed into memory.

Begin typing in your message pressing the space bar between words. The keyer echoes each character as it is typed. Press the BACK SPACE key to delete the last character. In message program mode *only*, press CTRL+BACK SPACE to delete the last word.

At the end of your message, press ENTER to end your message. The keyer will respond by sending an end-of-message character (di-dah-di-dah-dit) and save your message. It will automatically insert “]” to the end of your message.

If you accidentally enter “[“ during the message, you will have to use “]” to end your message – this allows carriage returns (produced by ENTER) in the message. The open square bracket “[” tells the keyer to replace the ENTER key with the close square bracket “]” as the end-of-message key.

Refer to “The Memory” section on page 36 for explanation of the MFJ-495’s message memory and how to use the embedded commands to enhance your message.

Quick Speeds

Each of the four Users has four pre-set memories to store the overall speed, so the speed can be quickly changed during an exchange. This works similar to your car radio’s pre-set station memories. To store the current overall speed into one of these pre-set memories, press CTRL+F9 to CTRL+F12. To recall a pre-set speed to use as the current speed, press ALT+F9 to ALT+F12.

The Terminal

Using the MFJ-495 with a Terminal Program

The Keyer Terminal mode allows a computer to talk to your MFJ-495. All code sent from the paddle and keyboard is echoed to the Keyer Terminal. All commands are accessible through the Keyer Terminal.

Your computer will need a terminal program to talk to the keyer. The program should be capable of uploading and downloading ASCII text files. Any good commercial or freeware terminal program should be satisfactory for use with this keyer.

After you have connected the MFJ-495 to the serial port of your computer with the correct cable, turn on your computer and load your terminal program. Set the baud rate to 1200, data bits to 8, parity to none, and stop bits to 1. Also, set the flow control to Xon/Xoff. Now turn on your MFJ-495. You should type something on the computer. Whatever you type should appear on the LCD display, which shows that everything is working properly between the computer and keyer. If you do not, recheck your terminal program and serial port cable connection.

You are ready to send with the keyer. To make a special prosign with the keyer terminal, begin the prosign with "<" and end the prosign with ">". For example, to make the prosign \overline{SN} types <SN>. This will remove the inter-character spaces between the characters making it a prosign. Any prosign can be made this way, even special local prosigns. Another method is to enclose the prosign with backslashes such as \SN\.

Note: The open angle bracket "<" enables prosign mode and the close angle bracket ">" disables prosign mode; while the backslash "\" toggles the prosign mode on and off. A word space also disables prosign mode.

Tip: All keystrokes and commands from the Keyer Terminal can also be used via the Keyboard.

Setup Commands

Press the tilde "~" key to enter command mode and the keyer responds with "CO" (dah-di-dah-dit dah-dah-dah). Enter a setup command. If the command is invalid then the keyer will send an error character (di-di-di-di-di-di-di-dit) and return the keyer to normal mode. If the user wishes to re-attempt modifying features using command mode, he must re-enter command mode by pressing "~" key again. If you enter the command mode accidentally, press ESC key at any time to exit. At any time, press ENTER to accept or ESC to cancel. Refer to the appendix "Setup Commands" on page 48 for a table of these commands.

- B#** **Bank** – selects the current memory bank, where # is A, B, C or D. Each memory bank has eight message blocks of 256 characters each, except the last block.
- C#** **Character space** – increases the inter-character space with # standard intra-character spaces, where # is a single digit from 0 to 9. This allows the normally three-unit long inter-character space up to 12 units long. Note the inter-character space is always at least four units shorter than the word space. Therefore, you might have to increase the word spacing before adjusting the character space.

Press either the “-” or “+” (or “=”) to decrease or increase character spacing, or enter one digit 0 to 9 to set the character spacing. Press ENTER to accept and exit, or press ESC to cancel and exit.

D **Decrement** – decrements the serial number by one, effectively canceling the automatic increment applied when last played from a message. The decrement function accommodates re-sending the last serial number, as might be needed when a repeat of a contest exchange is requested, or canceling the exchange with a station that proved to be a “dupe”. The unit will echo a "D" (dah-di-dit) for every number that is decrement. Decrement serial number 0001 rolls over to 9999, because the number 0000 is not used.

E## **Edit** – allows the operator to append onto or edit an existing message memory, where the first # is the message number 1 to 8 and the second # is the bank A to D. The keyer will display your message to the last word. You can then enter more text or erase existing words, just like the procedure when loading a message.

F## **Farnsworth** – uses to enable Farnsworth mode and spacing. Farnsworth spacing adds more time between characters to slow down the overall sending speed. The advantage of this is that, by hearing the characters sent at a faster speed, you learn to recognize each character by its distinctive rhythm, rather than by trying to "count dits." This greatly assists you in copying Morse code at higher speeds. The Farnsworth speed, however, must be higher than the overall speed. Setting ## to 00 or less than or equal to the overall speed will disable Farnsworth mode.

Press either the “-” or “+” (or “=”) to decrease or increase speed, or enter two digits 10 to 99 to set the Farnsworth speed or 00 to turn off Farnsworth mode. Press ENTER to accept and exit, or press ESC to cancel and exit

Note: It is recommended the Farnsworth mode be disabled when sending with the paddle. When Farnsworth mode is enabled, the paddle will send code at the Farnsworth speed, not the overall speed.

G# **Gap (word space)** – increases the word space with # standard intra-character spaces, where # is a single digit from 0 to 9. This allows the normally seven-unit long word space up to 16 units long. Note the word space is always at least four units longer than the inter-character space.

Press either the “-” or “+” (or “=”) to decrease or increase word spacing, or enter one digit 0 to 9 to set the word spacing. Press ENTER to accept and exit, or press ESC to cancel and exit.

H **Hand key** – enters the hand key mode to use the SPACE key as a hand (straight) key. The keyer responds with "HK" (di-di-di-dit dah-di-dah). Dots and dashes are made manually by using the space bar on your keyboard. That is, keying follows closure of the dot or dash paddle or the SPACE key, allowing hand-sent code. Normal keyer operation is regained by squeezing both paddles or by pressing the ESC key.

Tip: The space bar on the keyer terminal does not work properly in hand-key mode, because of the typematic delay of the computer keyboard.

I# **Iambic** – enables iambic A or B mode where # represents A or B, or disables iambic operation with # = N. The keyer will respond with "A" (di-dah), "B" (dah-di-di-dit), or "OFF" (dah-dah-dah di-di-dah-dit di-di-dah-dit). Press ESC to cancel and exit.

J#### **PTT hang time** – sets the PTT (push-to-talk) hang time to #### millisecond, where #### represents four digits in the range of 0001 to 9999. This controls the time between when CW

- keying is ended and when the PTT will de-assert. You may adjust this to your liking for on-the-air sending.
- Press either the “-” or “+” (or “=”) to decrease or increase the hang time, or enter up to four digits 0001 to 9999 to set the hang time. Press ENTER to accept and exit, or press ESC to cancel and exit.
- K##** **Keying compensation** – sets the keying compensation to ## millisecond, where ## represents two digits in the range of 00 to 25. Some radios have a key delay of 5 ms or more. By entering K05, the keyer will add 5 ms to the dots and dashes and subtract 5 ms from the intra-character spaces. Although similar to increasing weight, this adjustment is independent of the speed. This setting is used primarily to correct keying distortion by certain transceivers and to eliminate the problems with a transmitter key delay.
- Press either the “-” or “+” (or “=”) to decrease or increase compensation, or enter up to two digits 00 to 25 to set the compensation time. Press ENTER to accept and exit, or press ESC to cancel and exit.
- L##** **Lag (keying delay)** – sets the keying delay to ## millisecond, where ## represents two digits in the range of 00 to 20. This setting is used primarily to accommodate switching delay in certain station setup. It is used in conjunction with the PTT line to delay the keying output until all the switching is finished; that is, the keying output is lagged behind the sidetone audio and the PTT output. This controls the time between when PTT is asserted and when CW keying will start.
- Press either the “-” or “+” (or “=”) to decrease or increase delay, or enter up to two digits 00 to 20 to set the delay time. Press ENTER to accept and exit, or press ESC to cancel and exit.
- M#** **Monitor** – enables (#=Y) or disables (#=N) the sidetone monitor, or toggles the sidetone monitor on or off without the #. If the sidetone is turned off, it will still play command messages and status information. To conserve power, the keyer should be operated with the monitor off in favor of the rig’s sidetone.
- To change Monitor mode type “~M” followed by “Y” for on, “N” for off, or ENTER to toggle. The keyer will respond with “ON” or “OFF”. Press ESC or any other key to cancel and exit.
- N####** **Number** – sets the serial number. The serial number can be set from 0000 to 9999 (0000 will be converted to 0001). Enter up to four digits to set the current serial number and press ENTER to accept and exit, or press ESC to cancel and exit.
- O#** **Output** – enables (#=Y) or disables (#=N) the keying output, or toggles the keying output on or off without the #. If the output is turned off, no signal goes to the Keying Output or the PTT Output to allow practice operation. The output is temporarily disabled during memory message storing, command mode operation, status information, and keyer setup.
- To change Output mode type “~O” followed by “Y” for on, “N” for off, or ENTER to toggle. The keyer will respond with “ON” or “OFF”. Press ESC or any other key to cancel and exit.
- P#** **Paddle** – selects paddle mode of automatic (#=A), semi-automatic (bug, #=S) or hand-key (#=H) mode. With the automatic option, the keyer functions as an iambic keyer for use with a dual-lever paddle. As an iambic keyer, the MFJ-495 has dot and dash memories for "squeeze keying" and functions just like other iambic keyers, both standalone keyers and those built into radios. With semi-auto, the keyer can be used with a single-lever key, with dots generated automatically and dashes formed manually by the user. This emulates the function of a mechanical semi-automatic "bug." You also may use this unit with a straight

key or a bug, connect the straight key or bug to the ground and the dash line. With the hand-key option, both the dot and dash lines can be used to connect to a straight key. Notice hand-key mode may not be used to enter messages or commands.

Note: In hand-key mode using the paddle, the MFJ-495 will not display the code sent or record to the keyer memory. Also, the difference between this and the Hand-key command is that this command affects the paddle only.

Q# **Queue** – enables (#=Y) or disables (#=N) the message queue, or toggles the message queue on or off without the #. Queue mode enables the user to load messages into a buffer to play sequentially. In queue mode, if you press a message button while a message is playing, that message will play after the current message is done. When queue mode is off, pressing a message button will abort any message being played and play the new message. When on, up to 16 button presses are stored in order and acted upon in succession as each message is completed.

To change Queue mode type “~Q” followed by “Y” for on, “N” for off, or ENTER to toggle. The keyer will respond with “ON” or “OFF”. Press ESC or any other key to cancel and exit.

Note: Disabling the queue mode increases the message stack size to 24 levels deep used by the embedded Call command.

R## **Ratio** – sets the speed ratio of the Speed control, where ## represents two digits in the range of 02 to 20. The speed at the full clockwise position of the control is ## times that of the speed at the full counter-clockwise position.

Press either the “-” or “+” (or “=”) to decrease or increase ratio, or enter up to two digits 02 to 20 to set the speed ratio. Press ENTER to accept and exit, or press ESC to cancel and exit.

S## **Speed** – sets the overall code speed to ## WPM, where ## represents two digits in the range of 05 to 99. By "overall" speed, we mean the speed at which the words or groups are sent. A "word" is defined as 50 units of time, and the word "PARIS" is exactly 50 units in length. Therefore, if "PARIS" is sent 13 times in one minute, the sending speed is 13 wpm.

Standard Morse code timing defines a dit as one unit of time and a dah as three units of time. Within each character, there is one unit between elements (dits and dahs). Three units separate characters and seven units separate words. Farnsworth spacing (see above) will increase the amount of time between characters and words. Note that setting the overall speed greater than or equal to the Farnsworth speed will disable Farnsworth spacing.

Press either the “-” or “+” (or “=”) to decrease or increase speed, or enter up to two digits 05 to 99 to set the code speed. Press ENTER to accept and exit, or press ESC to accept and exit.

T## **Tone** – sets the sidetone frequency to approximately ##0 Hz, where ## represents two digits in the range of 30 to 99. The MFJ-495 features smooth, clean audio, with sine wave output, instead of the harsh square wave audio used by many other keyers. Also, the MFJ-495 produces each dit and dah with a rise and decay time of approximately 5 milliseconds, avoiding the "spikes" that cause distracting key clicks. The MFJ-495's audio sounds like that of a good CW transceiver.

Notice an alternating series of dots and dashes are sent to the sidetone monitor to assist in the setting of the desired sidetone frequency. Press either the “-” or “+” (or “=”) to decrease or increase tone frequency, or enter two digits 30 to 99 to set the tone frequency. Press ENTER to accept and exit, or press ESC to cancel and exit.

U# **User** – selects the current user, where # represents the digit 1 to 4. User mode is provided to support four operators with different configuration settings, such as speed, weight, etc. This

- allows up to four operators to use the keyer without having to reconfigure all the settings for each operator. It also supports four different configuration settings for different contest exchanges.
- V** reVerse – reverses the sense of the dot and dash paddles. When using paddles, the MFJ-495 normally expects the dot paddle to be connected to the tip of the plug and the dash paddle to be connected to the plug's ring. If your paddles are wired in the opposite manner, or you wish to change between right and left-handed operators, you may reverse the paddles.
- W####** Weight – sets the automatic code weighting between ## percent at the counter-clockwise position and ## percent at the clockwise position of the Speed control, where each ## represents two digits in the range of 25 to 75. Weighting varies linearly with the overall speed (automatic weight). Set both ## to the same value for constant weight, where weighting is independent of the overall speed.
- Weight is the duty cycle of a continuous string of dots, where 50% for perfect code. A higher weight produces a heavier sound and a lower weight causes characters to sound lighter. Weight can be set to remain constant and independent of speed, or it can be set to vary with the code speed.
- An alternating dot/dash is produced to aid in changing the weight. Press either the “-” or “+” (or “=”) key to change *constant* weight, or enter two pairs of two digits 25 to 75 to set automatic *linear* weight. Press ENTER to accept and exit, or press ESC to cancel and exit.
- Tip:** Type “W##” and then press TAB or ENTER to change only the counter-clockwise position weight. Type W, press TAB, and then type ## to change only the clockwise position weight.
- X** Xmit (carrier tune) – gives continuous key-down for adjusting transmitter or antenna tuner. Press any key to exit and release the key line.
- Y** Pulse tune – gives continuous adjustable pulses for adjusting transmitter or antenna tuner. Press F1 and F2 buttons to change the speed in the range of 50 to 99 WPM. Press F3 and F4 buttons to change the weight (duty cycle) in the range of 1% to 35%. Press ESC to exit and release the key line.
- Z####** Zeros and nines – sets the way zeros and nines in the serial number are sent. The first # sets whether to send the leading zeros as "0", "O", "T" or not at all (# = "N"). The second # sets whether the other zeros are sent as "0", "O" or "T". The last # sets whether the nines are sent as "9" or "N". For example, "ZO09" will send the leading zeros as "O" (dah-dah-dah), the other zeros as "0" (dah-dah-dah-dah-dah), and the nines as "9" (dah-dah-dah-dah-dit).
- ##** Play message – play message ## where the first # is the message number 1 to 8 and the second # is the memory bank A to D.
- >##** Save message – save message into the keyer memory ##, where the first # is the message number 1 to 8 and the second # is the memory bank A to D.
- <##** View message – view message ## where the first # is the message number 1 to 8 and the second # is the memory bank A to D.

Message Memory

To play a message in the terminal mode, type `~##` where the first # is message number 1 to 8 and the second # is memory bank A to D. The message is sent to the radio and echoed back to the terminal.

There are two different ways to save a message in the keyer terminal. You can type a message manually or load the message that you have saved in a text file. To save a message, type `~>##` where ## is the message number and bank followed by the content of the message. Begin typing in your message pressing the space bar between words. The keyer echoes each character as it is typed. Press the BACK SPACE key to delete the last character. At the end of your message, press ENTER to end your message. The keyer will respond by sending an end-of-message character (di-dah-di-dah-dit) and save your message. It will automatically insert "]" to the end of your message.

Alternately, type `~>##[message text]`. The keyer will end the message when the close square bracket "]" is received. When the open square bracket "[" is received, the keyer will use the close square bracket "]" (instead of the ENTER key) as the end-of-message indicator from that point on. This allows carriage returns, produced by the ENTER key, in the message.

To view the content of a message, type `~<##` where ## is the message number and bank. The memory will echo to the terminal.

Message Commands

To	Types
Play Message ##	~##
Save Message ##	~>##[message text] ~>##message text ENTER
View Message ##	~<##

Refer to "The Memory" section on page 36 for explanation of the MFJ-495's message memory and how to use the embedded commands to enhance your message.

Uploading and Downloading Messages:

To send messages either from your computer to the MFJ-495 or from the unit to your computer, you use a terminal program on the computer that is capable of transferring ASCII data. Configure the terminal software for 1200 baud, 8 data bits, no parity and one stop bit. To perform the transfer, you prepare either the computer or the Keyer to receive the file, and then send from the other.

Loading a Memory Block from the Computer

- Type "`~>##`", where the first # is a digit in the range of 1 to 8 for the message number and the second # is a letter in the range of A to D for the memory bank. The word RECEIVING will appear. The unit now is ready to receive data from your computer.
- Begin sending the data from the computer, and a progress indicator will appear on line two of the display. Invalid data will be ignored during the loading process. To stop loading data at any time, press the Menu button.
- The MFJ-495 automatically inserts an open square bracket "[" at the beginning of every message. This is its "beginning-of-message" indicator. When you press Menu or ENTER to end a transfer, the

unit inserts a close square bracket "]" as its "end-of-message" indicator. If you insert "[" at the end of your message file, the MFJ-495 will stop the transfer automatically when the close square bracket "]" is received. If the unit runs out of memory, the transfer will be stopped automatically.

- When the message transfer is completed, the unit will display RECEIVED XXXX where XXXX is a four-digit number indicating the number of characters received. This number includes the opening and ending message delimiters "[" and "]", plus any tabs and carriage returns.
- Normal operation is automatically resumed after approximately two seconds. Or, type "]" or press any button or paddle to return to normal operation immediately.

WARNING: Do not turn the power off while loading the memory; otherwise, the memory can be corrupted.

One way of speeding data transfer is to configure your terminal program to strip out linefeeds that follow carriage returns. While computers store a carriage return as two characters (the carriage return followed by a linefeed), the MFJ-495 stores only the carriage return and generates the linefeed following it during playback. The additional linefeed thus does not need to be transferred to the Keyer.

Sending Contents of a Memory Block to the Computer

- Configure your terminal program to receive ASCII data.
- Type "~<##", where the first # is a digit in the range of 1 to 8 for the message number and the second # is a letter in the range of A to D for the memory bank. SENDING XXXX will appear on the display, where XXXX is a four-digit number indicating the number of characters in the message plus the message delimiters "[" and "].
- A progress indicator will appear on the second line of the display to indicate the percentage of the message that has been sent.
- To stop the transfer at any time, press Menu or ESC.
- Return to normal operation when the transfer is completed.

The Memory

Message Memory

You may compose messages on a computer and load them into the MFJ-495's memory. The unit's memory system is quite flexible and allows up to 32 messages to be saved. One message can call another for additional flexibility. Using the memories, you may prepare the text for a classroom or over-the-air code practice session in advance. Also, a complete set of QSO exchange can be prepared and loaded into the MFJ-495. The memory is non-volatile, so it is saved even when the power is turned off and it does not require battery backup to preserve the recorded messages.

The unit's 8K memory is organized with four banks of eight blocks of 256-bytes each, except the last block. This composes of 32 individual memory blocks arranged in a stack structure, illustrated in the diagram shown in Figure 9. The memory banks are labeled A through D. The total memory available is 7.875K (8064) characters, where 1K = 1024. Each memory block is nominally $\frac{1}{4}$ K (256) characters, except the last block 8D that has a capacity of 128 characters. However, an individual message may fill more than one memory block. When this happens, blocks are filled sequentially, moving upward in the diagram. If a message begins in block 1B or higher memory blocks, $\frac{1}{4}$ K is reserved for each of the previous memory blocks.

For example, a message begun in block 3A will, if longer than $\frac{1}{4}$ K characters, flow into block 4A, then block 5A, and so on. However, it cannot flow downward into block 2A or block 1A. Because each of these lower memory blocks has $\frac{1}{4}$ K reserved, the message starting in block 3A can be a maximum of 7.375K (7552) characters.

The first character displayed on each message menu indicates the status of that memory block. If this character is an open square bracket “[” (the “beginning-of-message” indicator), the displayed block is the beginning of the message; otherwise, it is a portion of the previous memory block. Similarly, if the last character is a close square bracket “]” (the “end-of-message” indicator), the displayed block is the end of the message. Message playback will always start at the beginning of a message no matter which memory block of the message you have selected in the message menu.

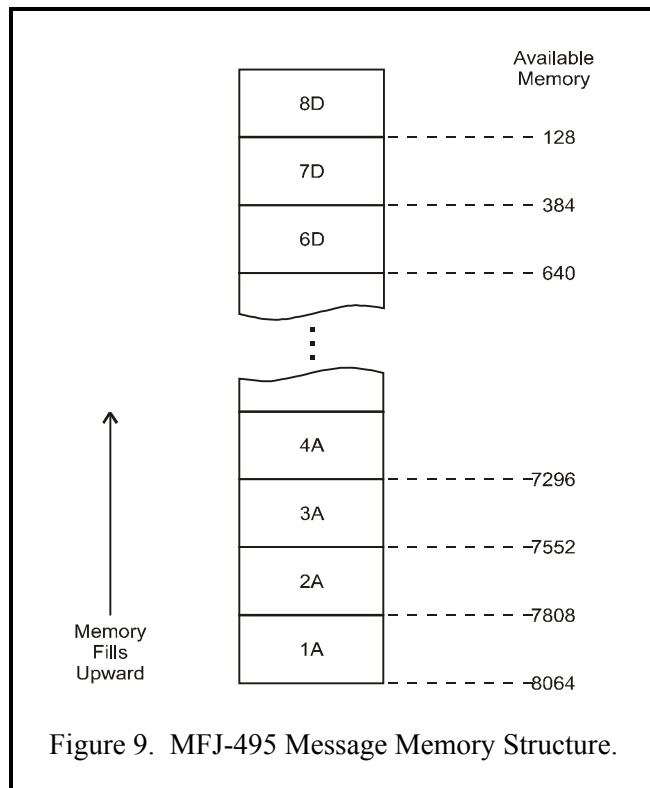

Figure 9. MFJ-495 Message Memory Structure.

For example, if the display shows [1A 2A 3A][4A], there is one continuous message occupying blocks 1A, 2A and 3A and another message in block 4A. In this case, selecting 1A, 2A or 3A for playback will always start the message from block 1A. This message begins in block 1A, flows into block 2A, and ends in block 3A.

Preparing Messages

To prepare messages, use an ASCII text editor on your computer. Valid characters for messages include all those listed in the chart “Morse Code Character Set” on page 45, the space, tab and carriage return. In addition, there are special characters, shown in the table below. Any invalid characters in a message will be ignored when the file is downloaded.

Special Characters

Characters	Represent
Square Brackets ([])	Delimiters for messages in memory.
Angle Brackets (< >)	Delimiters for custom prosigns.
Back Slashes (\ \)	Delimiters for custom prosigns.
Space+Slash (/)	Prefix for embedded commands.

Note: The Tab is displayed as a right arrow character and the Carriage Return is displayed as a left arrow character on the LCD. Both are sent as a word space.

You may control the unit's features during message playback by using embedded commands. These embedded commands can set sending speed, audio tone, and Farnsworth values, as well as provide great flexibility by allowing functions such as message looping and one message calling another. Embedded commands begin with a slash “/” and must enter as a separate word. Upper or lowercase letters may be used; embedded commands are not case-sensitive.

When a parameter such as Overall Speed or Tone is specified by an embedded command, the parameter will remain set during playback of that message. When playback of that message is completed or stopped, the value of the parameter will revert to the value set prior to the message playback.

Note: Adjusting the Speed control during message playback will undo the settings set by embedded commands /S, /U, /V and /W.

Embedded Commands

While in the message recording mode you may use embedded commands for special features. To use an embedded command, simply store the multi-character embedded command code within your message. To distinguish embedded commands from normal text, the embedded commands must be entered as a separate word; that is, it must be preceded by a word space (this leading space is ignored during playback). When encountered during message playback, the commands are executed. Note that if “/” is part of a single word, as in K5MFJ/4, it is sent as expected and is not executed as an embedded command.

To use an embedded command at the beginning of a message, the space preceding the “/” is optional; that is, “/” (without being preceded by a word space) at the beginning of a message is executed as an embedded command. Embedded commands that are *not* at the beginning of a message must be prefixed by “space + slash”. Embedded commands and their uses are explained below:

- // Slash – sends a slash character (dah-di-di-dah-dit) at the beginning of a message or immediately after a word space.
- /### Call – calls message ##, where the first # is a single digit in the range of 1 to 8 for the message number and the second # is a letter in the range of A to D for the memory bank.

This allows one message to be called from another. When playback of the called message is finished, playback continues with the rest of the calling message. This command has a 16-level deep stack; that is, a message can call another message, this message then calls another message which in turn calls another message and so on up to 16 times. One message should not call itself or any of its calling messages; otherwise, the stack will overflow resulting in infinite loop.

Note: The message stack size increases to 24 levels deep if the message queue is disabled.

- /D** **Decrement** – decrements the serial number. Serial number 0001 will decrement to 9999, skipping 0000 since it is not used. This feature allows a serial number to be sent twice in a message. For example: UR RST 559 559 SN /N /D SN /N.
- /F##** **Farnsworth** – sets the current Farnsworth speed to ## WPM, where ## represents two digits in the range of 10 to 99. Setting ## to 00 disables the Farnsworth mode (two zeros must be used here).
- /FU#** **Farnsworth Up** – increases the Farnsworth speed by # WPM, where # is a single digit in the range of 0 to 9. Increasing (wraparound) to 00 or less than or equal to the overall speed will disable the Farnsworth mode.
- /F+#** **Farnsworth Down** – decreases the Farnsworth speed by # WPM, where # is a single digit in the range of 0 to 9. Decreasing to 00 or less than or equal to the overall speed will disable the Farnsworth mode.
- /FD#** **Farnsworth Down** – decreases the Farnsworth speed by # WPM, where # is a single digit in the range of 0 to 9. Decreasing to 00 or less than or equal to the overall speed will disable the Farnsworth mode.
- /F-#** **Farnsworth Down** – decreases the Farnsworth speed by # WPM, where # is a single digit in the range of 0 to 9. Decreasing to 00 or less than or equal to the overall speed will disable the Farnsworth mode.
- /G#** **Gap** – inserts a gap of # standard intra-character spaces into the message, where # is a digit in the range of 1 to 9 (0 can be used but not practical). Invalid numeral code will automatically default to zero. This command is used to exaggerate inter-character and word spacing.
- /J##** **Jump** – jumps to the message ##, where the first # is a single digit in the range of 1 to 8 for the message number and the second # is a letter in the range of A to D for the memory bank. This allows you to continue your message into another message. This command can be used to create loop of multiple messages. Note that any character after “/J##” will not be sent.
- /L##** **Loop** – creates a loop of the *current* message block ## times, where ## represents two digits in the range of 01 to 99, and then continues with the rest of the message. When loop under 10 times, leading zero must be used. Set ## to 00 to create an infinite loop. Only up to two levels of loops are supported—the inner loop is finite and the outer loop is infinite, even if “/L00” is not used. Note that any character after “/L00” will not be sent. For example: CQ /L03DE K5MFJ /L00.
- /N** **Number** – inserts a contest serial number, in the range of 001 to 9999, into the message. Setup command Z controls the way zeroes and nines in the serial number are sent. Only three digits are sent for numbers less than 1000--use leading zeros when appropriate. The serial number is automatically post-incremented each time it is sent. The serial number increments from 0001 to 9999 and rolls over to 0001, skipping 0000 since it is not used. The serial number is set to the same one as before when power on. If a different serial number is desired, it must be re-programmed. The serial number can be set from 0000 to 9999 (0000 will automatically convert to 0001). For example: YOU ARE CONTACT NR /N.
- /P##** **Pause** – inserts a timed pause of ## seconds into the message, where ## represents two digits in the range of 00 to 99. When setting pauses under 10 seconds, leading zero must be used. Pauses greater than 99 seconds are obtained by using consecutive commands that total the desired value. For example: TIMEOUT 1 SEC /P01 TIMEOUT 1 MIN /P60 TIMEOUT 1 MIN 39 SEC /P99 TIMEOUT 2 MIN /P60 /P60.

- /R** **Repeat** – repeats playback from the beginning, even with calling messages. Note that any character after “/R” will not be sent.
- /S##** **Speed** – sets the current overall speed to ## WPM, where ## represents two digits in the range of 05 to 99. When setting speeds under 10 WPM, leading zero must be used.
- /SU#** **Speed Up** – increases the overall speed by # WPM, where # is a single digit in the range of 0 to 9.
- /S+#**
- /SD#** **Speed Down** – decreases the overall speed by # WPM, where # is a single digit in the range of 0 to 9.
- /S-#**
- /T##** **Tone** – sets the current sidetone frequency to approximately ##0 Hz, where ## represents two digits in the range of 30 to 99. Note that this command sets the sidetone to one of the 24 available frequencies.

##	Tone Freq.	##	Tone Freq.	##	Tone Freq.
30, 31, 32	305 Hz	54, 55, 56	549 Hz	78, 79, 80	793 Hz
33, 34, 35	335 Hz	57, 58, 59	579 Hz	81, 82, 83	823 Hz
36, 37, 38	366 Hz	60, 61, 62	610 Hz	84, 85, 86	854 Hz
39, 40, 41	396 Hz	63, 64, 65	640 Hz	87, 88, 89	884 Hz
42, 43, 44	427 Hz	66, 67, 68	671 Hz	90, 91, 92	915 Hz
45, 46, 47	457 Hz	69, 70, 71	701 Hz	93, 94, 95	945 Hz
48, 49, 50	488 Hz	72, 73, 74	732 Hz	96, 97, 98	976 Hz
51, 52, 53	518 Hz	75, 76, 77	762 Hz	99	1006 Hz

- /TU#** **Tone Up** – increases the sidetone frequency by # available frequency, where # is a single digit in the range of 0 to 9.
- /T+#**
- /TD#** **Tone Down** – decreases the sidetone frequency by # available frequency, where # is a single digit in the range of 0 to 9.
- /T-#**
- /U##** **Ultra Speed** – sets the ultra speed mode for a message at speed of ##0 WPM, where ## represents two digits in the range of 10 to 99. For example, “10” is 100 WPM and “99” is 990 WPM. This command is used primarily for meteor scatter work. Note that Farnsworth, Weighting, Character Space, Word Space, Keying Compensation, and Tone settings are disabled during ultra speed message transmission. Also, messages using both regular speed and ultra speed can be created. To exit the ultra speed mode, set ## to 00 such as /U00 and the message will return to regular speed. Alternately, the message can be returned to a lower regular speed by use of the /F, /S, or /W command.
- /V##** **Very Slow Speed** – sets the QRSS mode for a message at very slow speed with dots of ## seconds, where ## represents two digits in the range of 01 to 99. For example, “03” produces three-second dots, nine-second dashes, three-second intra-character spaces, nine-second inter-character spaces, and 21-second word spaces. QRSS is a very slow CW mode used by amateurs interested in very weak signal operation on VHF and above frequencies and on HF beacons. Note that Farnsworth, Weighting, Character Space, Word Space, Keying Compensation, and Tone settings are disabled during very slow speed message transmission. Also, messages using both regular speed and very slow speed can be created. To exit QRSS mode, set ## to 00 such as /V00 and the message will return to regular speed. Alternately, the message can be returned to a faster regular speed by use of the /F, /S, or /W command.
- During QRSS mode, the bottom line of the display reads `SPEED = QRSS##` where ## is the selected QRSS speed. Pressing the Menu button restores the main menu. The Speed, Farnsworth, Weight, and Tone main menus are not available in the QRSS mode.

- /W##** **Weight** – sets the code weight to ## percent, where ## represents two digits in the range of 25 to 75.
- /WU#** **Weight Up** – increases the code weight by # percent, where # is a single digit in the range of 0 to 9.
- /W+#**
- /WD#** **Weight Down** – decreases the code weight by # percent, where # is a single digit in the range of 0 to 9.
- /W-#**
- /X##** **Xmit** – keys the keyer for ## seconds, where ## represents two digits in the range of 01 to 99. When setting time under 10 seconds, leading zero must be used. Time greater than 99 seconds is obtained by using consecutive commands that total the desired value. Set ## to 00 to key continuously for tuning the transmitter. For example: **KEY 1 SEC /X01 KEY 1 MIN /X60 KEY 1 MIN 39 SEC /X99 KEY 2 MIN /X60 /X60 KEY INFINITE /X00.**

Appendices

Resetting the Keyer

Each time the keyer is turned off, the microprocessor powers down and saves all memories and configurations to non-volatile memory ready to be used the next time the unit is turned on again. If the keyer is not working properly, even on initial power on, try resetting to the factory defaults.

Factory Defaults

The unit is shipped with the following default settings for all users 1 to 4:

- Main Menu [1A][2A][3A][4A]
- Setup Menu Speed Ratio
- Memory Bank A
- Speed Control Range 13 to 39 WPM
- Speed Ratio 3-to-1
- Overall Speed 13 WPM
- Farnsworth off
- Weight 50% constant
- Character Space 3 units
- Word Space 7 units
- Keying Compensation 0 msec
- Keying Delay 0 msec
- PTT Hang Time 1000 msec
- Tone Frequency 701 Hz
- Serial Number 0001
- Leading Zeroes on and send as O (dah-dah-dah)
- Other Zeroes send as 0 (dah-dah-dah-dah-dah)
- Nines send as 9 (dah-dah-dah-dah-dit)
- Iambic Mode A
- Reverse Mode off (dot to tip, dash to ring)
- Paddle Mode automatic
- Monitor Mode on
- Output Mode on
- Queue Mode on
- Pulse Tune Speed 75 WPM
- Pulse Tune Weight 13% duty cycle
- Quick Speeds 13, 15, 18 and 20 WPM

To reset the keyer to these defaults:

1. Skip to step 6 if you want to reset the current user; otherwise continue with step 2.
2. Turn on the power to the keyer.
3. Press and hold the Menu button for two seconds to go to the setup menus.
4. Press Previous or Next button to go to the User menu.
5. Press Up or Down button to select the user to be reset to factory defaults.
6. Turn off the power to the keyer.
7. Press and hold *both* the Menu and F2 buttons while turning the power on.
8. Release the buttons when `DEFAULTS RESET` appears on the display.

- Resume with normal operation.

WARNING: If the MFJ-495 is behaving weird or acting erratic, try resetting the keyer to factory defaults.

Message Memory Reset

To erase all message memories, hold down the Menu and F4 buttons while turning the power on. A confirmation message ERASE ALL MSGS? will display. Press the [YES] button to clear all message memories, or press the [NO] button to cancel. Release the button to resume normal operation. Remember that all stored messages will be lost!

To erase a message, select that message for recording. Without typing or keying anything into memory, end the recording by typing ENTER or holding down any function button for two seconds. The keyer will respond with an end-of-message character (di-dah-di-dah-dit).

Self Test

A self-test routine will check the functions of the MFJ-495. This routine checks the display, the paddles, the front-panel buttons, the remote port, the internal memory and the audio circuitry. During the self-test, you may stop the test by turning off the unit; however, this should NOT be done during the memory test or the memory could be corrupted. The self-test can be completed in approximately 30 seconds.

Connections of the serial port and keyboard are not necessary for this test.

Note: Performing the self-test will reset the unit to its factory default settings for all four users and select user 1 as the current user.

Here is the self-test procedure:

- Turn off the power to the keyer.
- Connect a paddle to the Key Input jack. Connect a remote control to the Remote port if you have one.
- Turn Speed control to full clockwise position. Set volume to a comfortable listening level.
- Press and hold *only* the Menu button while turning the power on.
- The test begins by displaying a copyright message and firmware version number. This is the test of the display. This message is also sent to the serial port. Release the Menu button before the message completes.
- You will be prompted to press the dot and dash paddles. This assumes the dot paddle is connected to the tip of the plug and the dash paddle to the ring of the plug. The LED should blink once for each press.
- You will be prompted to press each of the front-panel buttons. The LED should blink once for each press.
- You will be prompted to press the dot and dash connections of the Remote port. If you don't have a remote control, you can use the paddle. The LED should blink once for each press.
- You will be prompted to press the function button connections of the Remote port. If you don't have a remote control, you can press the front-panel buttons. The LED should blink once for each press.
- Test the Speed control by turning it to full counter-clockwise then to full clockwise. The LED should blink once at each end.

11. The unit then tests its non-volatile memory. Notice this step will reset the unit to its factory default settings for all four users, and select user 1 as the current user.
12. If the unit is okay, a repetitive message `PASS` will be displayed and sent as audio. If there is a problem, a failure message will be displayed and sent.
13. Once you have confirmed that the audio is okay, turn the unit off.

Failure Message Meanings:

- `DASH FAIL` Dash paddle (ring of the plug) is shorted or improperly connected.
- `DOT FAIL` Dot paddle (tip of the plug) is shorted or improperly connected.
- `F1 FAIL` F1 button is shorted or improperly connected.
- `F2 FAIL` F2 button is shorted or improperly connected.
- `F3 FAIL` F3 button is shorted or improperly connected.
- `F4 FAIL` F4 button is shorted or improperly connected.
- `MEMORY FAIL` Non-volatile memory circuitry is improperly connected.
- `MENU FAIL` Menu button is shorted or improperly connected.
- `PD FAIL` Power down circuitry is bad.
- `SPEED FAIL` Speed control is bad.

Power Down Circuit Test

This test checks the power down circuitry. It is recommended that this test should be done immediately after the regular self test described above.

Note: *The keyer must be reset to factory defaults before performing this test.*

Here is the test procedure:

1. Make sure power to the keyer is off.
2. If the keyer has been reset to factory defaults, skip to step 7; otherwise continue with step 3.
3. Press and hold *both* the Menu and F2 buttons while turning the power on.
4. Release both buttons when `DEFAULTS RESET` appears on the display.
5. Make sure the display shows `[1A][2A][3A][4A]`; however, depending on your message memory, some brackets “[” and “]” might not show on your display.
6. Turn the power off.
7. Press and hold *only* the F2 button while turning the power on.
8. If the power down circuitry is okay, a repetitive message `PASS` will be displayed and sent as audio. If there is a problem, message `PD FAIL` will be displayed and sent as audio repetitively.
9. Turn the power off.

Troubleshooting

Q. Why can't I enable the Farnsworth mode?

A. The overall speed is at its maximum of 99 WPM.

Q. Why adjusting the Speed control does not seem to change the code speed?

A. The Farnsworth mode is enabled with speed greater than the maximum speed of the Speed control.

Q. When keying with the paddle, the Speed control is not working?

A. Disable the Farnsworth mode.

Q. Why do I get extra linefeeds when uploading to the computer?

A. Configure your terminal program to strip the linefeeds from the carriage returns.

Q. The keyer is acting erratic?

A. Reset the keyer to factory defaults setting by pressing both Menu and F2 buttons while turning the power on.

Q. How come I cannot increase the character spacing?

A. The word spacing must be at least four units more than the character spacing.

Q. The keyer keys continuously when I turn on the power?

A. Make sure the Manual Key jumper JMP3 is set to the correct logic.

Technical Assistance

If you have any problem with this unit first check the appropriate section of this manual. If the manual does not reference your problem or your problem is not solved by reading the manual you may call *MFJ Technical Service* at **662-323-0549** or the *MFJ Factory* at **662-323-5869**. You will be best helped if you have your unit, manual and all information on your station handy so you can answer any questions the technicians may ask.

You can also send questions by mail to MFJ Enterprises, Inc., 300 Industrial Park Road, Starkville, MS 39759; by FAX to 662-323-6551; or by email to techinfo@mfjenterprises.com. Please include a complete description of the problem, an explanation of exactly how you are using the unit when the problem arises, and a complete description of any equipment you are using with this unit, such as a computer (including applicable software) or radio. Also include the firmware version number of your unit.

Morse Code Character Set¹

A	di-dah	• –	N	dah-dit	– •
B	dah-di-di-dit	– • • •	O	dah-dah-dah	– – –
C	dah-di-dah-dit	– • – •	P	di-dah-dah-dit	• – – •
D	dah-di-dit	– • •	Q	dah-dah-di-dah	– – • –
E	dit	•	R	di-dah-dit	• – •
F	di-di-dah-dit	• • – •	S	di-di-dit	• • •
G	dah-dah-dit	– – •	T	dah	–
H	di-di-di-dit	• • • •	U	di-di-dah	• • –
I	di-dit	• •	V	di-di-di-dah	• • • –
J	di-dah-dah-dah	• – – –	W	di-dah-dah	• – –
K	dah-di-dah	– • –	X	dah-di-di-dah	– • • –
L	di-dah-di-dit	• – • •	Y	dah-di-dah-dah	– • – –
M	dah-dah	– –	Z	dah-dah-di-dit	– – • •
1	di-dah-dah-dah-dah	• – – – –	6	dah-di-di-di-dit	– • • • •
2	di-di-dah-dah-dah	• • – – –	7	dah-dah-di-di-dit	– – • • •
3	di-di-di-dah-dah	• • • – –	8	dah-dah-dah-di-dit	– – – • •
4	di-di-di-di-dah	• • • • –	9	dah-dah-dah-dah-dit	– – – – •
5	di-di-di-di-dit	• • • • •	0	dah-dah-dah-dah-dah	– – – – –
Period	[.]	di-dah-di-dah-di-dah	• – • – • –	<u>AAA</u>	
Comma	[,]	dah-dah-di-di-dah-dah	– – • • – –	<u>MIM</u>	
Question Mark or Request for Repetition	[?]	di-di-dah-dah-di-dit	• • – – • •	<u>IMI</u>	
Fraction Bar	[/]	dah-di-di-dah-dit	– • • – •	<u>DN</u>	
End of Message or Cross	[+]	di-dah-di-dah-dit	• – • – •	<u>AR</u>	
End of Work	[*]	di-di-di-dah-di-dah	• • • – • –	<u>SK</u>	
Double Dash, Pause or Break	[=]	dah-di-di-di-dah	– • • • –	<u>BT</u>	
Semicolon	[;]	dah-di-dah-di-dah-dit	– • • • – •	<u>KR</u>	
Colon	[:]	dah-dah-dah-di-di-dit	– – – • • •	<u>OS</u>	
Apostrophe	[']	di-dah-dah-dah-dah-dit	• – – – – •	<u>WG</u>	
Quotation Mark	["]	di-dah-di-di-dah-dit	• – • • – •	<u>AF</u>	
Hyphen or Dash	[-]	dah-di-di-di-di-dah	– • • • • –	<u>DU</u>	
Underline	[_]	di-di-dah-dah-di-dah	• • – – • –	<u>IQ</u>	
Dollar Sign	[\$]	di-di-di-dah-di-di-dah	• • • – • • –	<u>SX</u>	
Left Parenthesis	[(]	dah-di-dah-dah-dit	– • – – •	<u>KN</u>	
Right Parenthesis	[)]	dah-di-dah-dah-di-dah	– • – – • –	<u>KK</u>	
Wait	[&]	di-dah-di-di-dit	• – • • •	<u>AS</u>	
Understood	[!]	di-di-di-dah-dit	• • • – •	<u>SN</u>	
Starting Signal	[%]	dah-di-dah-di-dah	– • – • –	<u>KA</u>	
Error	[^]	di-di-di-di-di-di-di-dit	• • • • • • • •	<u>HH</u>	
At	[@]	di-dah-dah-di-dah-dit	• – – • – •	<u>AC</u>	
Paragraph	[#]	di-dah-di-dah-di-dit	• • – – • •	<u>AL</u>	
Invitation to Transmit		dah-di-dah	– • –	K	

1. FCC test requirement consists the 26 letters, the 10 numerals, the period, the comma, the question mark, AR, SK, BT and DN.

Signals Used in Other Radio Services

Interrogatory	di-di-dah-di-dah	• • - • -	<u>INT</u>
Emergency Silence	di-di-di-di-dah-dah	• • • • - -	<u>HM</u>
Executive Follows	di-di-dah-di-di-dah	• • - • • -	<u>IX</u>
Break-in Signal	dah-dah-dah-dah-dah	- - - - -	<u>TTTTT</u>
Emergency Signal	di-di-di-dah-dah-dah-di-di-dit	• • • - - - • • •	<u>SOS</u>
Relay of Distress	dah-di-di-dah-di-di-dah-di-dit	- • • - • • - • •	<u>DDD</u>

Some CW Abbreviations

73	Best regards	NR	Number; near
88	Love and kisses	NW	Now
ABT	About	OM	Old man
AGN	Again	OP	Operator
ANT	Antenna	R	Are; received; roger
BK	Back; break	RCVR	Receiver
CPY	Copy	RIG	Station equipment
CQ	Calling any station	RITE	Right
CUL	See you later	RST	Readability, strength, tone report
CU	See you	SIGS	Signals
DE	From	SKED	Schedule
DEG	Degree	STN	Station
DX	Distance; rare station	TEMP	Temperature
ES	And; "&"	TKS	Thanks
FB	Fine business; excellent	TNK	Thank
FER	For	TNX	Thanks
FREQ	Frequency	UR	Your; you're; you are
GA	Good afternoon	U	You
GE	Good evening	WL	Well; will
GM	Good morning	WTS	Watts
GN	Good night	WX	Weather
HR	Hear; here	XCVR	Transceiver
HW	How	XMTR	Transmitter
K	Go ahead	XYL	Wife (ex-young-lady)
MSG	Message	YL	Young lady

Meaning of Q Signals

QRA	The name of my station is
QRL	Do not interfere, Frequency busy
QRM	Being interfered with
QRN	Static
QRO	Increase power, High power
QRP	Decrease power, Low power
QRQ	Send faster
QRR	I am ready for automatic operation
QRS	Send more slowly
QRT	Stop sending
QRU	I have nothing for you
QRX	I will call again at ..., wait
QRZ	Who is calling me, I am
QSB	Your signal is fading
QSD	Your keying is defective
QSK	I can hear you between my signals
QSL	I am acknowledging receipt
QSU	Reply on this frequency or mode
QSX	I am listening to ... on ... kHz
QSY	Change frequency, change to xmit on ... kHz
QTH	My location (home) is
QTR	The correct time is
QTS	I will send so my frequency can be measured
QUB	Here is the info you requested
QUM	The distress traffic has ended

Send a "?" after a Q signal to ask for information or an action.

Example: QRZ: station (call) is QRZ?: what is your station (call)?

Setup Commands

Command	Via Menu	Via Paddle	Via Keyboard	Via Terminal
Bank	[MENU] + [F1] [MENU] + [F2] [MENU] + [F3] [MENU] + [F4]	[COM] + B#	~B# CTRL+B # F9 F10 F11 F12	~B#
Character Space	Char Space	[COM] + C#	~C# CTRL+C #	~C#
Decrement	[DEC]	[COM] + D	~D CTRL+D	~D
Edit	--	[COM] + E##	~E## CTRL+E ##	~E##
Farnsworth	Farnsworth	[COM] + F##	~F## CTRL+F ##	~F##
Gap (Word Space)	Word Space	[COM] + G#	~G# CTRL+G #	~G#
Handkey	Paddle: Handkey	[COM] + H	~H CTRL+H	~H
Iambic	Iambic	[COM] + I#	~I# CTRL+I #	~I#
PTT Hang Time	PTT Hang Time	[COM] + J#####	~J##### CTRL+J #####	~J#####
Keying Compensation	Key Compensation	[COM] + K##	~K## CTRL+K ##	~K##
Lag (Keying Delay)	Key Delay	[COM] + L##	~L## CTRL+L ##	~L##
Monitor	Monitor	[COM] + M#	~M# CTRL+M # ALT+F5	~M#
Number	Serial Number	[COM] + N#####	~N##### CTRL+N #####	~N#####
Output	Output	[COM] + O#	~O# CTRL+O # ALT+F6	~O#
Paddle	Paddle	[COM] + P#	~P# CTRL+P #	~P#
Queue	Queue	[COM] + Q#	~Q# CTRL+Q # ALT+F7	~Q#
Ratio	Speed Ratio	[COM] + R##	~R## CTRL+R ##	~R##
Speed	Overall Speed	[COM] + S##	~S## CTRL+S ## CTRL+UP CTRL+DOWN CTRL+LEFT CTRL+RIGHT	~S##

Command	Via Menu	Via Paddle	Via Keyboard	Via Terminal
Tone	Tone	[COM] + T##	~T## CTRL+T ## SHIFT+UP SHIFT+DOWN SHIFT+LEFT SHIFT+RIGHT	~T##
User	User	[COM] + U#	~U# CTRL+U # ALT+F1 ALT+F2 ALT+F3 ALT+F4	~U#
reVerse	Reverse	[COM] + V	~V CTRL+V	~V
Weight	CCW Weight CW Weight	[COM] + W#####	~W##### CTRL+W ##### ALT+UP ALT+DOWN ALT+LEFT ALT+RIGHT	~W#####
Xmit (carrier tune)	[CXT]	[COM] + X	~X CTRL+X ALT+F8	~X
pulse tune	[PXT]	[COM] + Y	~Y CTRL+Y	~Y
Zeroes and nines	Leading Zeroes Other Zeroes Nines	[COM] + Z###	~Z### CTRL+Z ###	~Z###

Note: Terminal commands can be used via the keyboard, but not vice versa.

Table 4. Setup Commands.

Schematic

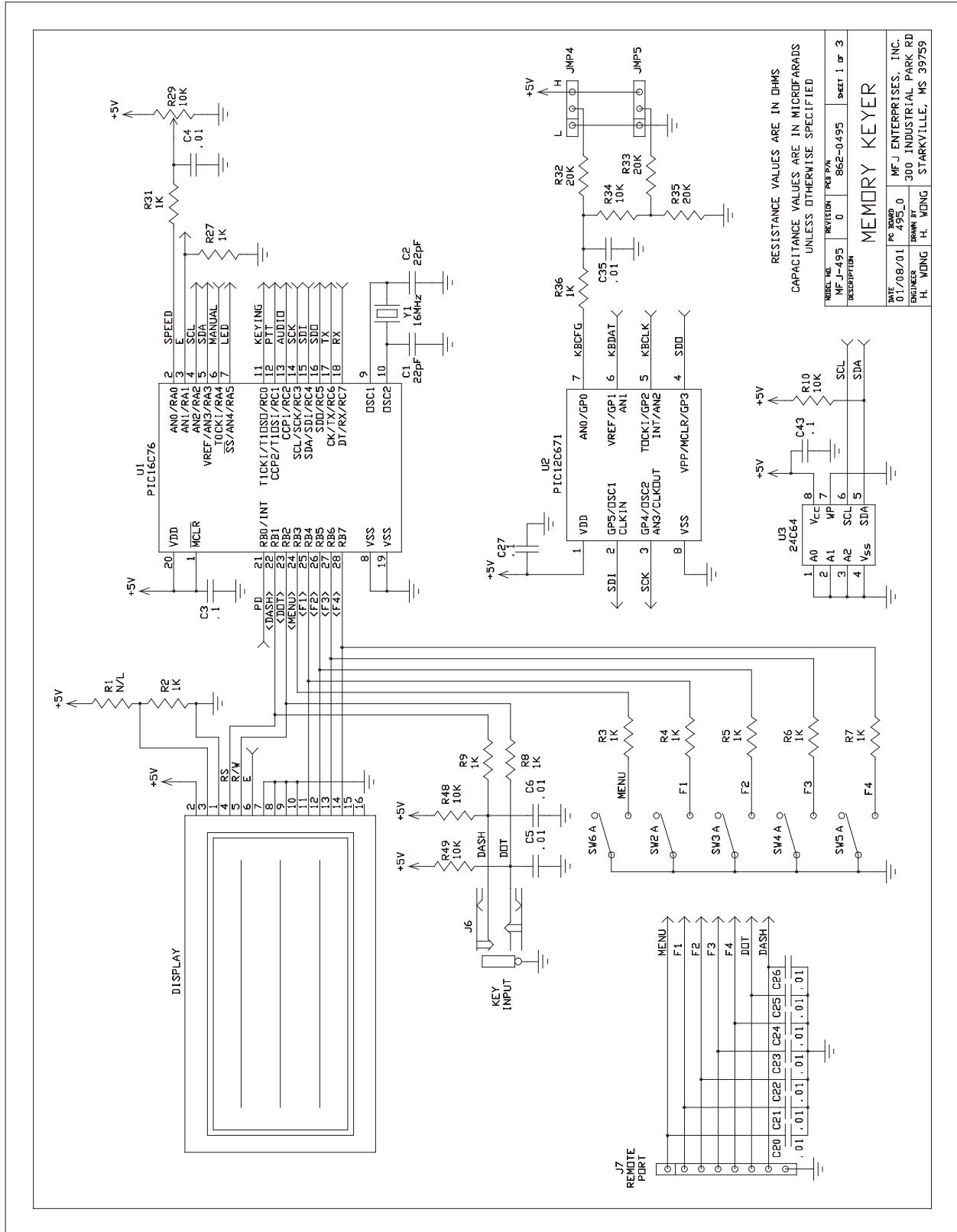

RESISTANCE VALUES ARE IN OHMS
CAPACITANCE VALUES ARE IN MICROFARADS
UNLESS OTHERWISE SPECIFIED

MODEL NO.	REVISION	POP PAK	SHEET 1 OF 3
MF J-495	0	862-0495	

MEMORY KEYS

DATE	PC BOARD	MFJ ENTERPRISES, INC.
01/08/01	495_0	300 INDUSTRIAL PARK RD.
ENGINEER	DRAWN BY	STARKVILLE, MS 39759
H. WONG	H. WONG	

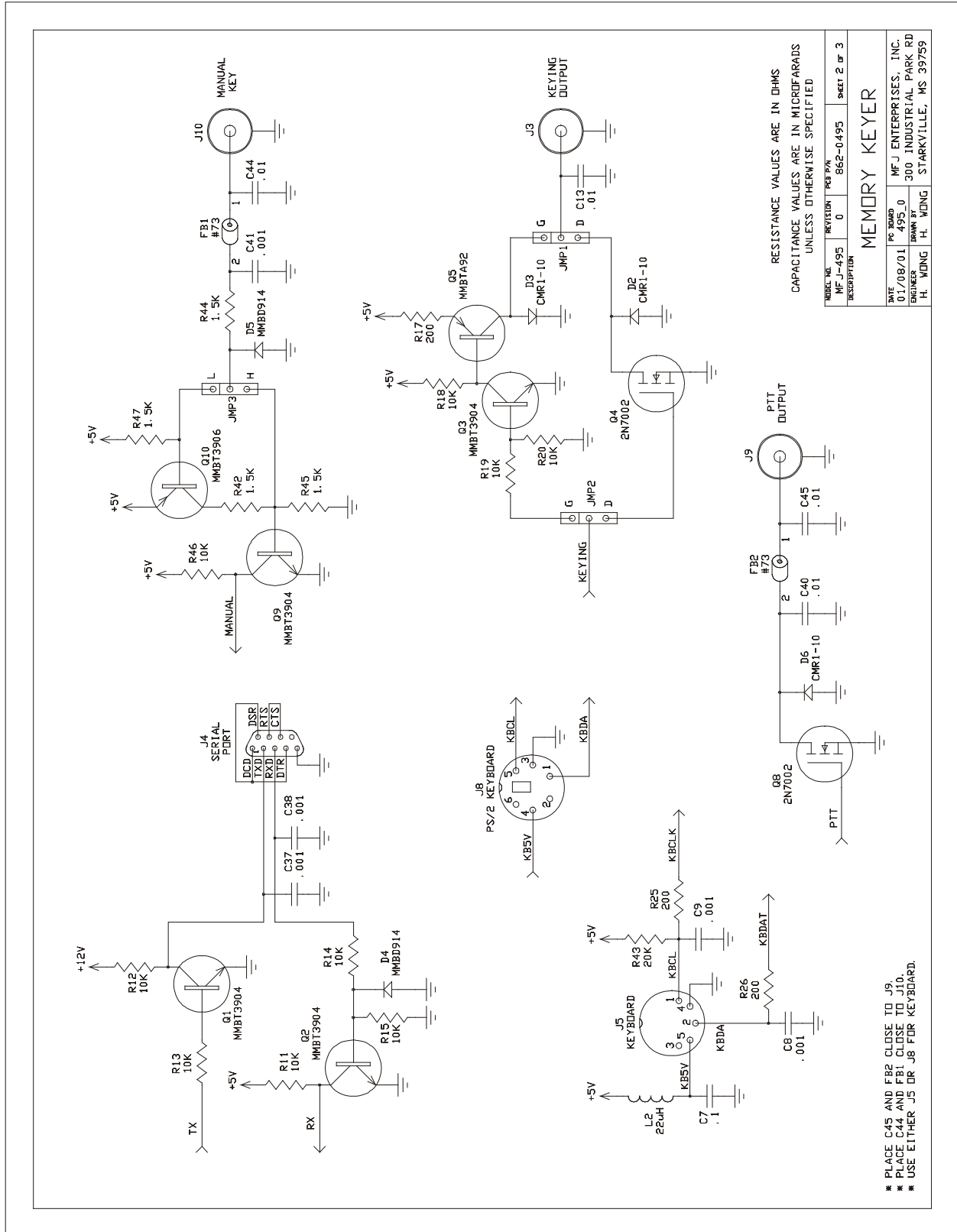

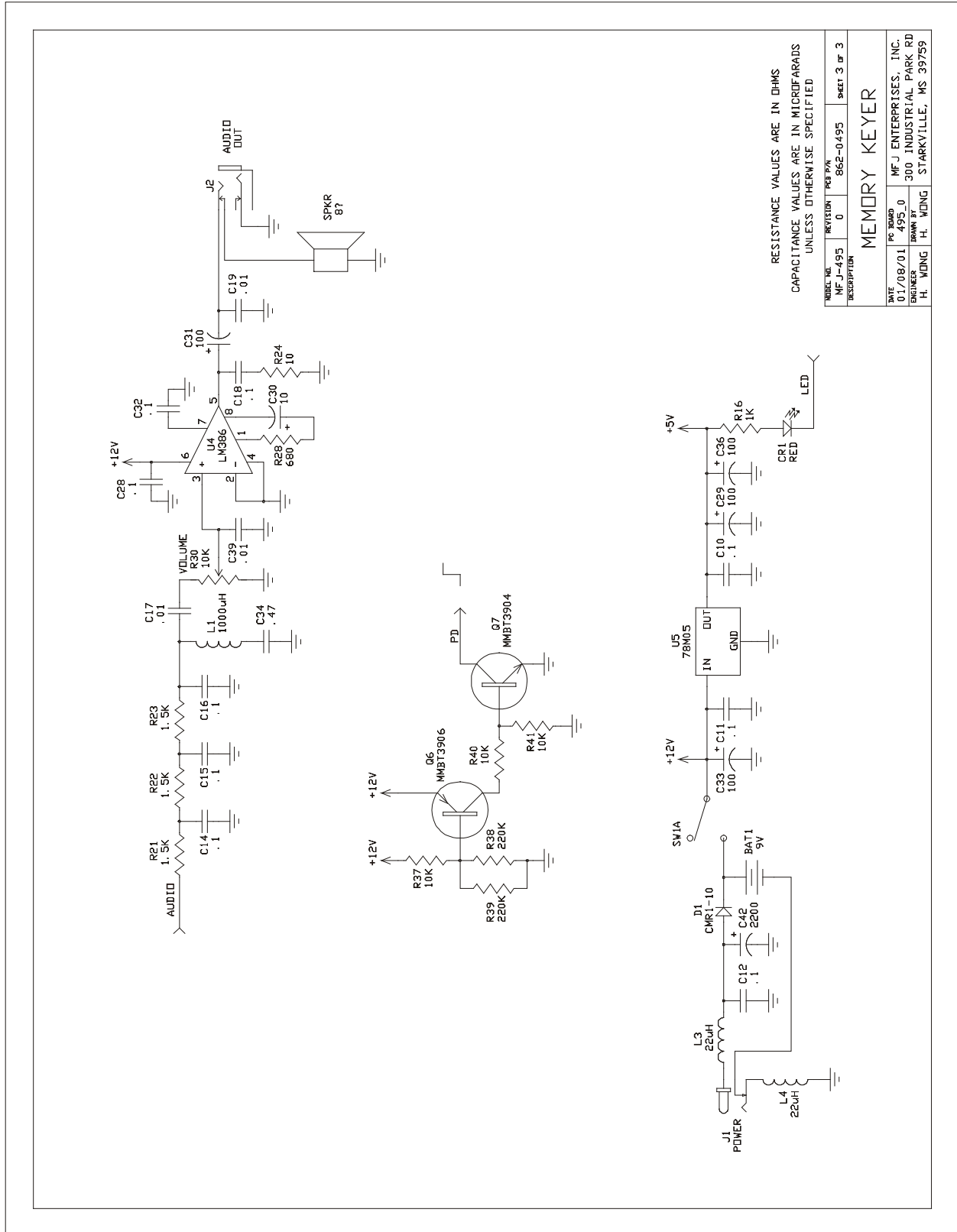

RESISTANCE VALUES ARE IN OHMS
 CAPACITANCE VALUES ARE IN MICROFARADS
 UNLESS OTHERWISE SPECIFIED

MODEL NO.	REVISION	PREP. P/N	SHEET 3 OF 3
MF J-495	0	862-0495	
MEMORY KEYS			
DATE	PC BOARD	MFJ ENTERPRISES, INC.	
01/08/01	495_0	300 INDUSTRIAL PARK RD.	
ENGINEER	DRAWN BY	STARKVILLE, MS 39759	
H. WONG	H. WONG		

LIMITED 12 MONTH WARRANTY

MFJ Enterprises, Inc. warrants to the original owner of this product, if manufactured by MFJ Enterprises, Inc. and purchased from an authorized dealer or directly from MFJ Enterprises, Inc. to be free from defects in material and workmanship for a period of 12 months from date of purchase provided the following terms of this warranty are satisfied.

1. The purchaser must retain the dated proof-of-purchase (bill of sale, canceled check, credit card or money order receipt, etc.) describing the product to establish the validity of the warranty claim and submit the original or machine reproduction of such proof of purchase to MFJ Enterprises, Inc. at the time of warranty service. MFJ Enterprises, Inc. shall have the discretion to deny warranty without dated proof-of-purchase. Any evidence of alteration, erasure, or forgery shall be cause to void any and all warranty terms immediately.
2. MFJ Enterprises, Inc. agrees to repair or replace at MFJ's option without charge to the original owner any defective product under warrantee provided the product is returned postage prepaid to MFJ Enterprises, Inc. with a personal check, cashiers check, or money order for **\$10.00** covering postage and handling.
3. This warranty is **NOT** void for owners who attempt to repair defective units. Technical consultation is available by calling the Service Department at 662-323-0549 or the MFJ Factory at 662-323-5869.
4. This warranty does not apply to kits sold by or manufactured by MFJ Enterprises, Inc.
5. Wired and tested PC board products are covered by this warranty provided **only the wired and tested PC board product is returned**. Wired and tested PC boards installed in the owner's cabinet or connected to switches, jacks, or cables, etc. sent to MFJ Enterprises, Inc. will be returned at the owner's expense unrepaired.
6. Under no circumstances is MFJ Enterprises, Inc. liable for consequential damages to person or property by the use of any MFJ products.
7. **Out-of-Warranty Service:** MFJ Enterprises, Inc. will repair any out-of-warranty product provided the unit is shipped prepaid. All repaired units will be shipped COD to the owner. Repair charges will be added to the COD fee unless other arrangements are made.
8. This warranty is given in lieu of any other warranty expressed or implied.
9. MFJ Enterprises, Inc. reserves the right to make changes or improvements in design or manufacture without incurring any obligation to install such changes upon any of the products previously manufactured.
10. All MFJ products to be serviced in-warranty or out-of-warranty should be addressed to:

MFJ Enterprises, Inc.
300 Industrial Park Road
Starkville, Mississippi 39759 USA

and must be accompanied by a letter describing the problem in detail along with a copy of your dated proof-of-purchase.

11. This warranty gives you specific rights, and you may also have other rights which vary from state to state.



MFJ ENTERPRISES, INC.
300 Industrial Park Road
Starkville, MS 39759

MFJ-495 Manual
Version 0D
Printed In U.S.A. 06/2009